

FURUNO

OPERATOR'S MANUAL

VHF RADIOTELEPHONE

MODEL FM-8500



FURUNO ELECTRIC CO., LTD.
NISHINOMIYA, JAPAN

© **FURUNO ELECTRIC CO., LTD.**

9-52 Ashihara-cho,
Nishinomiya, Japan

Telephone : 0798-65-2111

Telefax : 0798-65-4200

Your Local Agent/Dealer

All rights reserved.

Printed in Japan

PUB.No. OME-56030

(TATA) FM-8500

FIRST EDITION : DEC. 1995

K : MAY. 17,2002



* 0 0 0 8 0 7 6 2 9 0 1 *



* O M E 5 6 0 3 0 K 0 0 *

CANCELLING A FALSE DISTRESS ALERT

1. Switch off transmitter immediately.
2. Switch equipment on and set to Channel 16.
3. Make broadcast to "All Stations" giving your vessel's name, callsign and DSC number, and cancel the false distress alert.

Example message:

All Stations, All Stations, All Stations
This is NAME, CALLSIGN,
DSC NUMBER, POSITION.

Cancel my distress alert of
DATE, TIME, UTC.
=Master, NAME, CALLSIGN.
DSC NUMBER, DATE, TIME UTC.



SAFETY INSTRUCTIONS

"**DANGER**", "**WARNING**" and "**CAUTION**" notices appear throughout this manual. It is the responsibility of the operator of the equipment to read, understand and follow these notices. If you have any questions regarding these safety instructions, please contact a FURUNO agent or dealer.

The level of risk appearing in the notices is defined as follows:



DANGER

This notice indicates a potentially hazardous situation which, if not avoided, will result in death or serious injury.



WARNING

This notice indicates a potentially hazardous situation which, if not avoided, could result in death or serious injury.



CAUTION

This notice indicates a potentially hazardous situation which, if not avoided, could result in minor or moderate injury, or property damage.

 **WARNING**



Do not open the equipment except to replace paper or fuse.

Hazardous voltage which can cause electrical shock, burn or serious injury exists inside the equipment. Only qualified personnel should work inside the equipment.

Do not disassemble or modify the equipment.

Fire, electrical shock or serious injury can result.

Turn off the power immediately if water leaks into the equipment or the equipment is emitting smoke or fire.

Continued use of the equipment can cause fire or electrical shock.

Do not place liquid-filled containers on the top of the equipment.

Fire or electrical shock can result if a liquid spills into the equipment.

Do not operate the equipment with wet hands.

Electrical shock can result.

Keep heater away from equipment.

Heat can alter equipment shape and melt the power cord, which can cause fire or electrical shock.

 **CAUTION**

Use the proper fuse.

Use of a wrong fuse can result in fire or permanent equipment damage.

Do not use the equipment for other than its intended purpose.

Personal injury can result if the equipment is used as a chair or stepping stool, for example.

Do not place objects on the top of the equipment.

The equipment can overheat or personal injury can result if the object falls.

Table of Contents

FOREWORD	vii
-----------------------	------------

System Configuration	viii
-----------------------------------	-------------

1. VHF Radiotelephone Operational Overview

1.1 Controls, Indications	1-2
1.2 Telephone Operation	1-3

2. DSC Terminal Operational Overview

2.1 DSC Messages	2-1
2.2 Controls, LEDs	2-3
2.3 Basic Operation	2-5
2.4 Auto Acknowledge	2-8

3. DSC Distress Alert

3.1 Distress Alert Transmission	3-1
3.2 Manual Entry of Ship's Position and Time	3-4
3.3 Receiving Distress Alert from Other Ship	3-5
3.4 Distress Relay	3-9

4. DSC Communication

4.1 Transmitting Individual Calls	4-1
4.2 Receiving Individual Call (ACK RQ)	4-5
4.3 Transmitting All Ships Calls	4-9
4.4 Receiving All Ships Calls	4-12
4.5 Creating and Saving Transmit Messages	4-15
4.6 Writing Over Files	4-17
4.7 Retrieving, Transmitting Files	4-18
4.8 Transmit/Receive Message Memory	4-19

5. Other Calling Types and Other Functions

5.1 Other Calling Types	5-1
5.2 Making Telephone Calls	5-4
5.3 Receiving Telephone Call from Coast Station	5-7
5.4 Other Station IDs and Telephone Nos.	5-8

6. Other Settings

6.1 Printer Setup (Auto/Manual)	6-1
6.2 Turning Keyboard Click ON/OFF.....	6-4
6.3 Aural Alarm Setup	6-5

7. System Confirmation

7.1 Confirming Own Ship's ID	7-1
7.2 Confirming ROM Version	7-2
7.3 Confirming VHF Section Settings	7-3
7.4 Confirming VHF Channels	7-4
7.5 Confirming Tx Output Power	7-5

8. Maintenance & Troubleshooting

8.1 Maintenance	8-1
8.2 Troubleshooting.....	8-1
8.3 Diagnostic Test	8-2

9. Specifications

10. Menu List

APPENDIX 1 Marine VHF Channel Lists	AP-1
APPENDIX 2 Memory Channel List	AP-2
APPENDIX 3 DIGITAL INTERFACE (IEC 61162-1 Edition 2).....	AP-3

Declaration of conformity to type

FOREWORD

Thank you for purchasing this VHF Radiotelephone FM-8500. We are confident you will discover why FURUNO has become synonymous with quality and reliability.

Dedicated in the design and manufacture of marine electronics equipment for half a century, FURUNO Electric Company has gained an unrivaled reputation as a world leader in the industry. This is the result of our technical excellence as well as our worldwide distribution and service network.

Please carefully read and follow the safety information and operating and maintenance instructions set forth in this manual before attempting to operate the equipment and conduct any maintenance. Your VHF Radiotelephone FM-8500 will perform to the utmost of its ability only if it is operated and maintained in accordance with the correct procedures.

Features

The FM-8500 is a highly advanced, semi-duplex, fully synthesized 25W VHF transceiver with DSC terminal, designed to satisfy the stringent requirements of marine communications. It complies with GMDSS carriage requirements for safety and general communications.

- Conforms to the following standards and regulations:
 - IMO A. 694(17)
 - IMO A. 803(19)
 - IMO A. 524(13)
 - IMO MSC 68(68), MSC/Circ.862
 - IEC-61097-3/7/8
 - IEC-60945 (3rd edition)
 - IEC-61162-1
 - ETS 300 338, 301 033, 300 162
 - ITU-R M.493-9, M.541-8, M.689-2
- Automatic position and time input and update with connection of EPFS (Electronic Position-Fixing Equipment).
- Optional printer can automatically print out received messages and test results.
- Log stores 50 each of latest ordinary, distress and transmitted messages, in separate memory blocks.
- One-touch testing facility.

Program number

DSC 0550182010 (version 1.12)
RT 0550183006 (version 1.06)

System Configuration

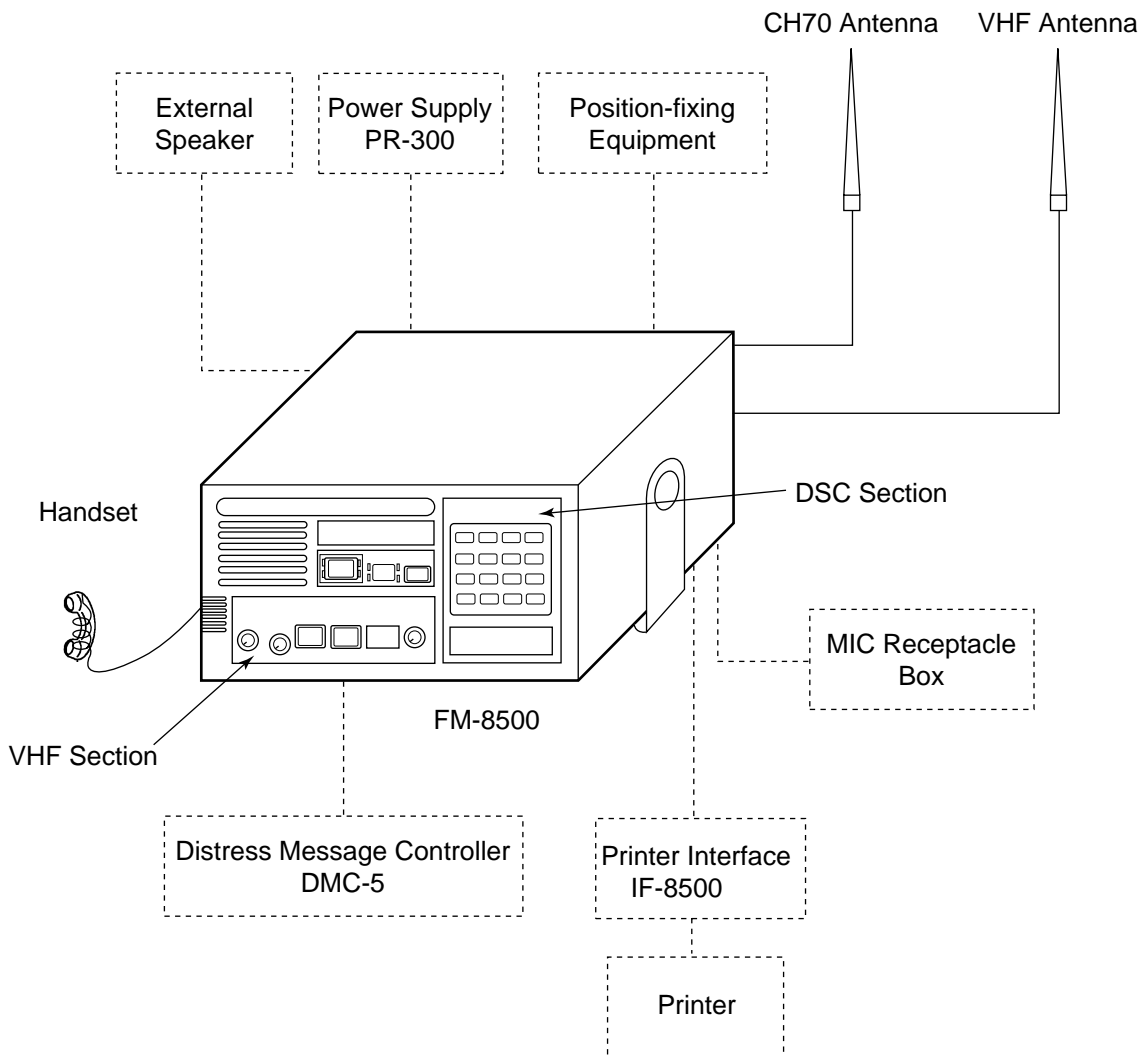

Figure 1 FM-8500 system configuration

This page is intentionally left blank.

1. VHF Radiotelephone Operational Overview

The FM-8500 system consists of a main transceiver unit and two antennas. The transceiver unit contains a VHF transmitter, receiver, and channel 70 watch receiver module. The performance and operation are controlled on its front panel. The antenna may be of any type available from FURUNO or market and the recommended type is a vertically polarized non-directional type. The first antenna works for transmitting and receiving and the 2nd antenna for watch keeping.

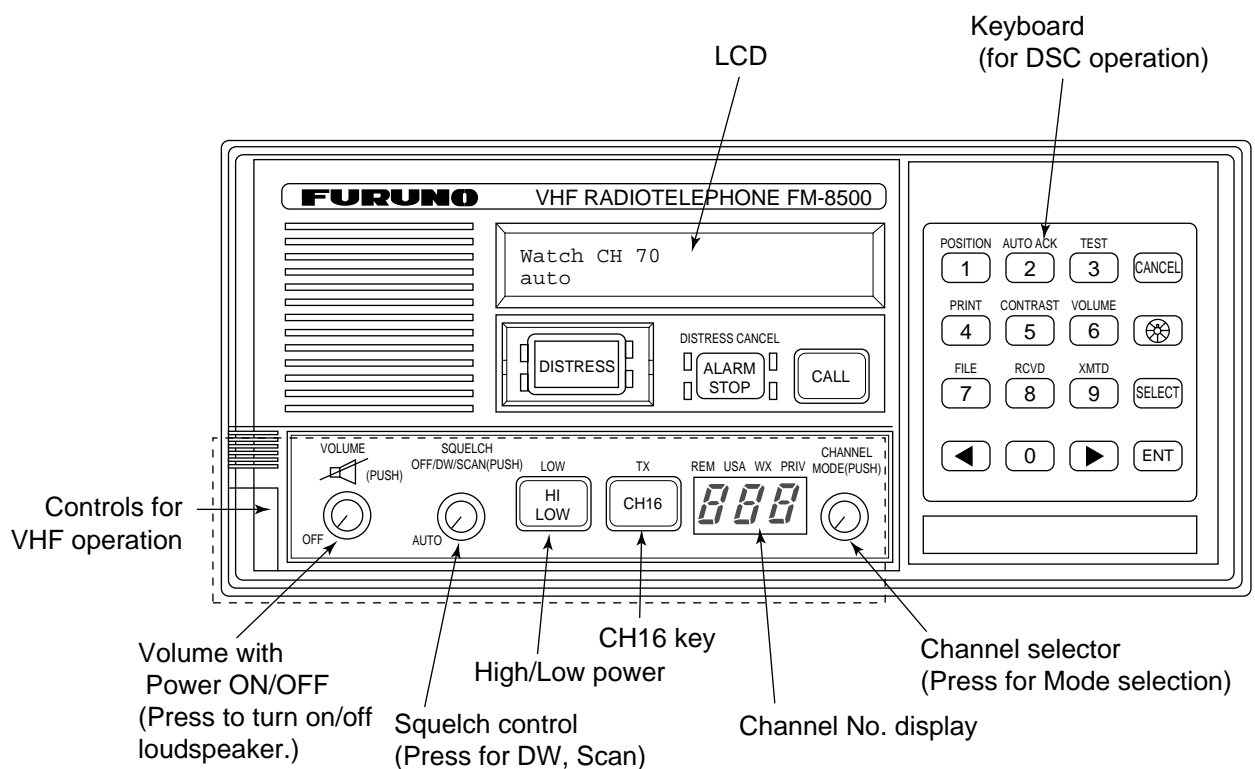

Figure 1-1 FM-8500 transceiver unit

1.1 Controls, Indications

Controls

CHANNEL/ MODE	Selects a channel. Pressing the Channel Selector (rotary control) changes the mode from INTL, USA, WX, and PRIV in this order. (Appears when USA/WX and PRIV mode are registered.)
SQUELCH/ DW/SCAN	Mutes the receiver when no signal is present on the channel selected. Auto position automatically reduces white noise. Pressing the control changes the operating modes: Dual watch, Scan and Off.
VOLUME/ LOUDSPEAKER	Turns the power on or off and adjusts the volume of the built-in loudspeaker. Pressing the control turns the loudspeaker on or off.
HI/LOW key	Alternates high or low output power.
CH16 key	Selects channel 16.

Indications

The display shows the following indications;

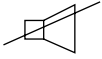
Indication	Function
	Internal loudspeaker OFF, by pressing the VOLUME control. Internal loudspeaker is automatically turned off whenever the handset is picked up.
LOW	Lights for low RF power.
TX	Lights while transmitting.
REM	Lights when FM-8500 is under control by RB-700 Remote Station.
USA	USA mode. (Some ITU duplex channels are used as simplex channels.)
WX	Lights when a weather channel is selected. (Available in US version.)
DW/SCAN	DW for Dual Watch; SCAN for scanning.

1.2 Telephone Operation

Turning the power on and off

To turn the power on, turn the VOLUME control clockwise until you hear a click. To turn the power off, turn the control fully counterclockwise until you hear the click.

Selecting channel modes

While pressing the channel selector, press the CH16 key to select the channel mode, International, USA (in the case of USA version), private (if authorized), or weather mode (USA version). The International version of FM-8500 has no such selection.

On the weather channel mode, a beep is emitted when the weather alert tone is received.

NOTE: Private channels are available only where permitted by the authorities.

Selecting channels

Rotate the CHANNEL selector clockwise (counterclockwise) until a desired channel is reached.

Adjusting volume

The VOLUME control adjusts the volume of the loudspeaker.

Adjusting squelch

The SQUELCH control adjusts the squelch threshold level. Adjust it so that white noise heard in the loudspeaker just fades out. Perform this operation when no traffic is being received. AUTO squelch automatically reduces white noise. Usually select "AUTO" position. Avoid turning the squelch too far clockwise: you may miss a long distance communication.

Note: To obtain correct scan watch/dual watch response, adjust the SQUELCH control precisely.

Every press of the SQUELCH control changes the function as follows:

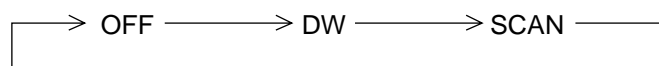

Transmitting

Press the PTT (Press-to-talk) switch on the handset or microphone to talk, and release it to listen for the response.

Output power

- BEFORE transmitting, think about the subjects which have to be communicated and, if necessary, prepare written notes to avoid unnecessary interruptions and ensure that no valuable time is wasted on a busy channel.
- Listen before commencing to transmit to make certain that the channel is not already in use.

Each press of the [HI/LOW] key selects HI or LOW output power. The transmitter power is automatically set for low on the following channels.

International: CH15, CH17

USA: CH13, CH15, CH17, CH67; to operate USA channel 13 or 67 in high power, keep [HI/LOW] pressed while talking into the handset.

Turning the loudspeaker on/off

To turn the loudspeaker on/off, press the VOLUME control. The loudspeaker off mark appears when the speaker is off. The loudspeaker is automatically turned off when the telephone handset is used on semi-duplex channels.

Channel 16

Press the [CH16] key to select channel CH16, International Calling and Safety Channel.

This is an international calling and safety channel. The use is limited for distress, safety and calling. The transmission on CH16 (156.800 MHz) should be limited to within 1 minute except for distress calling.

Avoid calling on Channel 16 for purposes other than distress, urgency and very brief safety communications when another calling channel is available.

Dual watch

The dual watch allows you to keep watch on channel 16 and another channel. CH16 and another channel are watched at intervals of 0.15 seconds and one second, respectively.

To start DW, press the SQUELCH control once. When the receiver finds a signal on channel 16, it locks on CH16 and restarts dual watching after the signal on CH16 has gone. If another channel has traffic, it still continues dual watch. The speech is heard intermittently. If you are annoyed with the intermittence, turn off DW by pressing the PTT switch on the handset or pressing the SQUELCH control.

Scanning

The receiver scans all channels in the selected channel mode in ascending channel order, watching CH16 between channels as below:

To start scanning, press the SQUELCH control and SCAN is started. When the receiver finds a signal, scanning is stopped on that channel and starts dual watch on it and channel 16.

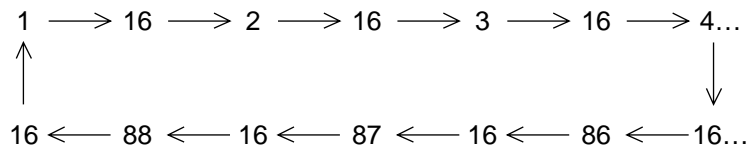

Time-out-timer (U.S.A. type only)

The FM-8500 is equipped with an automatic timing device that deactivates the transmitter and reverts the transceiver to the receive mode after an uninterrupted transmission period of 5 minutes.

Remarks on voice communications

Automatic acknowledge is automatically changed to manual acknowledge when voice communications begin. (The "auto" indication, however, remains on the screen.) This is done to prevent break in communications. Automatic acknowledge is automatically restored once voice communications are terminated.

Priority

The priority of the equipments is as follows.

DSC section of FM-8500 > Wing handset > Handset of FM-8500
> Remote Station RB-700

This page is intentionally left blank.

2. DSC Terminal Operational Overview

2.1 DSC Messages

The contents of a DSC message change with format specifier (calling category).

1. Format: Calling type

IND: Individual Call
TEL: Telephone Call
ALL: All Ships Call
R/A: Relay All Ships Call
R/S: Relay Specific Ships Call
GRP: Group Call
POS: Position Request Call

2. Address: Station's 9-digit ID number

IDs starting with "00" are coast stations, those starting with "0" are group IDs or another IDs are ship's IDs.

3. Category: Communication priority

There are four communication priorities as below:

DIS: A vessel is in grave and imminent danger and requests immediate assistance.
URG: Announce important safety information or request medical assistance.
SAF: Transmitting a message containing an important navigational or an important meteorological warning.
ROU: For routine (individual) calling.

4. DSC: DSC channel

A DSC channel is different from the usual communication channel because it is not used for voice communication but rather DSC and acknowledging receipt of message.

5. Telecom1: Telecommand

The communication mode; simplex or semi-duplex.

6. Channel: Voice communication channel

To communicate with a coast station, a station sends its position data to the coast station and the coast station determines the channel to use. A station may only use CH16 (distress channel) in the event of distress.

7. Pos: Ship's position

Position input by radionavigational equipment.

8. UTC: Universal Time Coordination

The equipment contains a clock. External time input from radionavigational equipment cannot be used.

9. ACK RQ (BQ):

Acknowledge request (RQ) or acknowledge reply (BQ).

2.2 Controls, LEDs

Controls

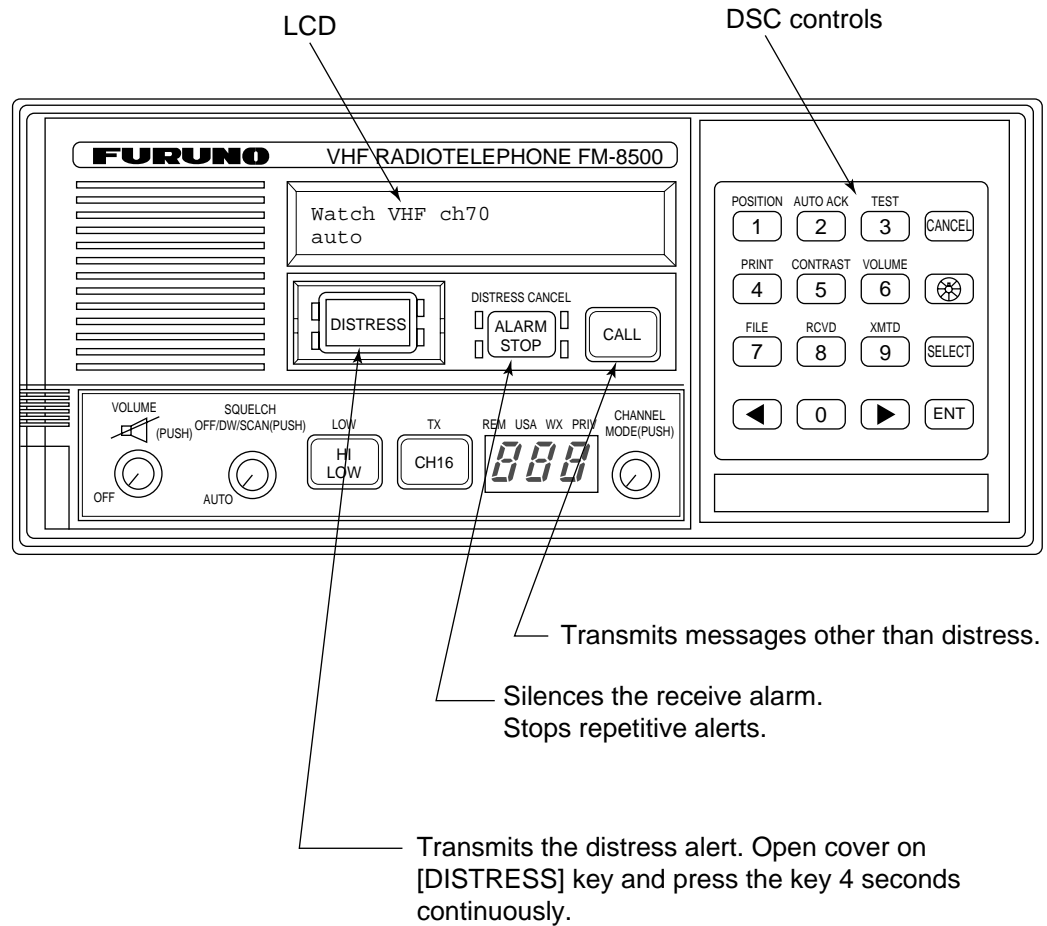
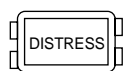

Figure 2-1 FM-8500 transceiver unit

LEDs



The four LEDs surrounding the [DISTRESS] key light when the key is pressed, 4 seconds continuously.



- The upper two of the four LEDs surrounding the [ALARM STOP] key blink (and alarm sounds) when distress or urgent message is received. LEDs can be extinguished and alarm silenced by pressing the [ALARM STOP] key.
- The lower two LEDs (Green) blink (and alarm sounds) when message other than distress/urgent are received. Alarm is automatically silenced five seconds after message is received.

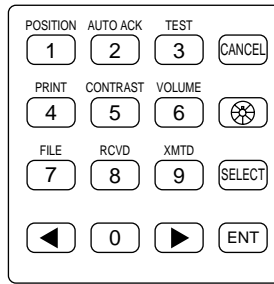

Figure 2-2 Keyboard

Key	Function/Purpose
0 ~ 9	Enter numeric data.
CANCEL	Cancels wrong data and restores previous menu.
	Adjusts illumination of LED and keys in four levels.
SELECT	1. Display "Set up menu" (Main menu). 2. Changes settings of items appearing with blinking question mark.
ENT	Registers key input. (Blinking item is registered when key is pressed.)
	1. Shifts the cursor leftward. 2. Restores previous display when pressed at displays with a blinking question mark.
	Shifts the cursor rightward.
POSITION 1	Ship's position and time are shown while pressed and held down.
AUTO ACK 2	Turns automatic transmission of acknowledge call (AUTO ACK) on/off. (Refer to page 2-8.) Note that distress alert cannot be automatically acknowledged by "auto acknowledge".
TEST 3	Conducts self-tests.
PRINT 4	Printing. (This is also available for automatic setting of the printer.)
CONTRAST 5	Adjusts contrast of LCD in eight levels.
FILE 7	Retrieves files.
RCVD 8	Displays contents of received messages (Storage capacity: 100 files, 50 each of distress and other). (Refer to page 4-21.)
XMTD 9	Displays contents of transmitted messages (Storage capacity: 50 files). (Refer to page 4-19.)
VOLUME 6	Not used.

2.3 Basic Operation

Normal display

When the FM-8500 is turned on, the following display appears. This display is known as the “normal display.”

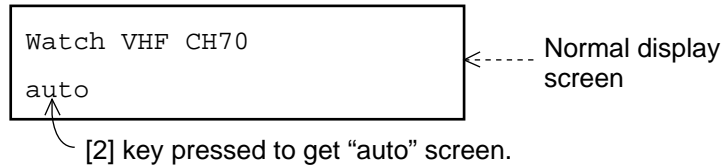

Should you get lost in operation you can return to the normal display by pressing the [CANCEL] key several times.

Selecting and registering items

The arrow keys ([◀] and [▶]) function to select items on the LCD. After selecting item, press the [ENT] key to register it.

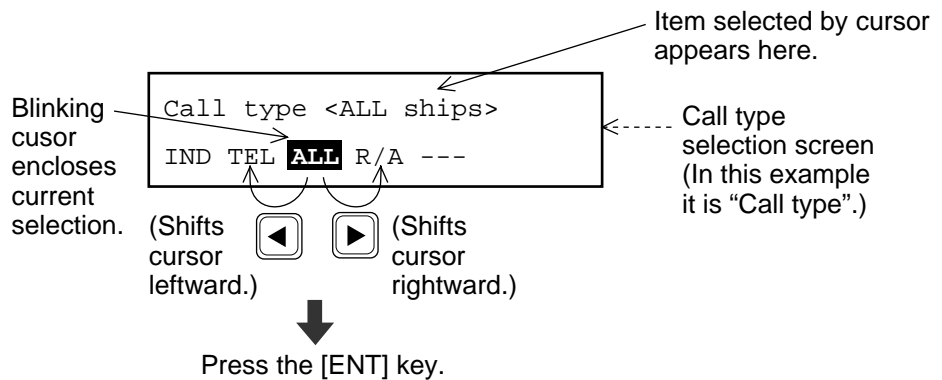

When blinking question mark appears

Press the [ENT] or [SELECT] key depending on your desire.

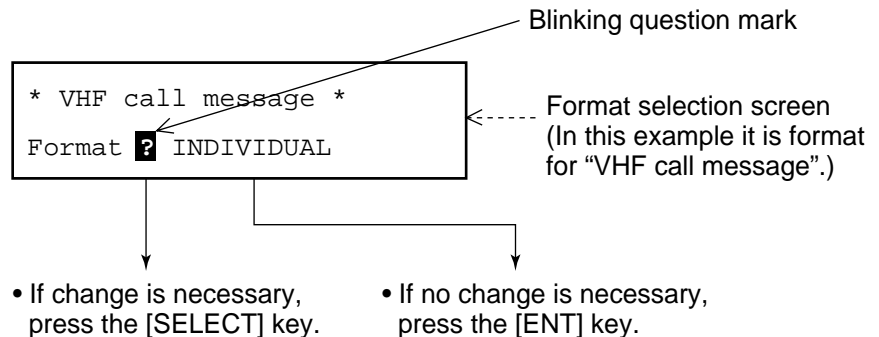

Preparing and Transmitting Messages

There are two methods by which you can prepare and transmit messages, and they are shown below.

Preparing message for immediate transmission

Prepare message and then transmit it.

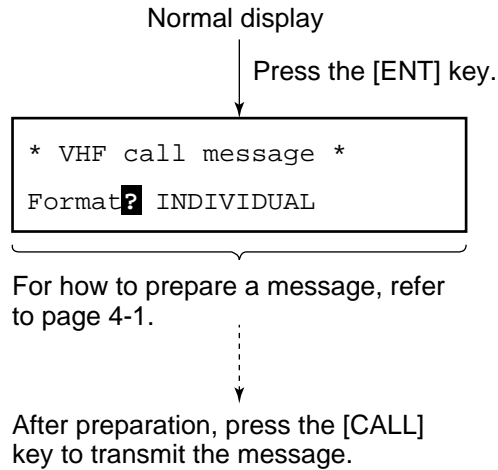

Preparing and storing message for later transmission

Prepare messages excluding distress message and save them to the memory. (Maximum 99 files) You may retrieve and transmit a memory-stored message as follows.

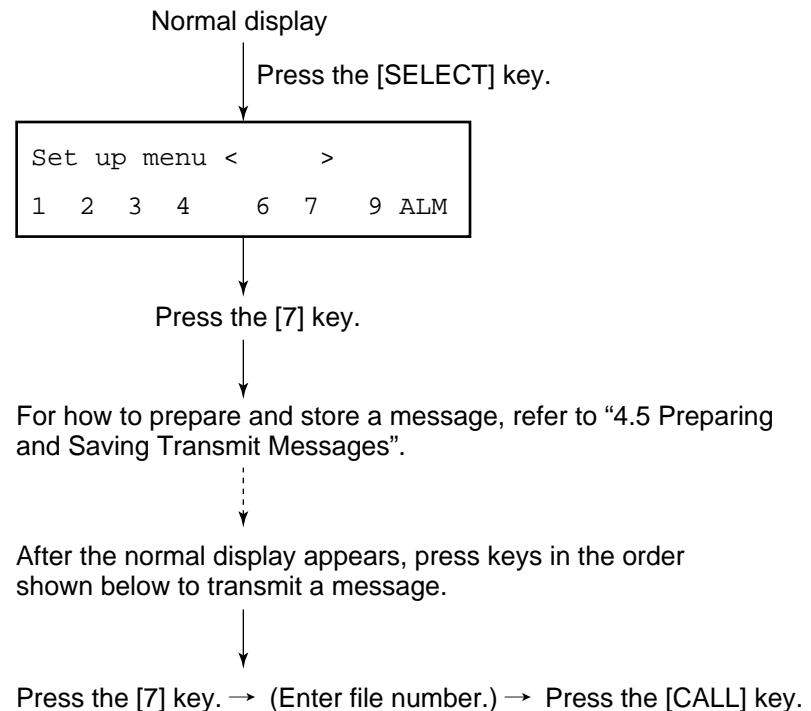

Status of FM-8500 during DSC Call

When the distress alert is transmitted (by pressing the [DISTRESS] key), the output power of the FM-8500 is automatically set to maximum (25 W).

Key entry of VHF

The FM-8500's keyboard accepts no key input while DSC message is transmitted. (Distress call: inoperative about 3 seconds, other calls: inoperative about 0.5 seconds.)

To unlock it manually, if necessary, press the [CANCEL] key.

The VHF section keyboard accepts no key input when the PTT switch is operated.

2.4 Auto Acknowledge

Auto acknowledge functions to automatically acknowledge individual calls. Press the [2] (AUTO ACK) key to automatically transmit the acknowledge back (ACK BQ) to the sending station when an individual call is received.

An individual message cannot be automatically acknowledged when it is received while the handset is off hook.

When auto acknowledge is disabled

- Automatic acknowledge is disabled when an Error Checking Code (ECC) appears at the end of a receive message.
- A distress alert is received. (A distress alert cannot be acknowledged automatically.)

Turning & AUTO ACK on/off

Each press of the [2] key enables/disables auto acknowledge function..

“auto” function

Provides automatic acknowledge of individual calls. Automatic acknowledge, however, is disabled when conducting voice communications.

“manual” function

Manual acknowledge of all calls. However, an all ship's call is automatically acknowledged when no voice communications are taking place when the call is received. See page 4-12 for details.

3. DSC Distress Alert

3.1 Distress Alert Transmission

Basic procedure for transmitting distress alert

In the GMDSS, a vessel in distress contacts a coast station by DSC to request help.

The procedure for transmitting a distress alert is as shown below. If the [DISTRESS] key is accidentally pressed, press the [ALARM STOP] key or [CANCEL] key within five seconds after pressing the [DISTRESS] key to cancel the distress alert.

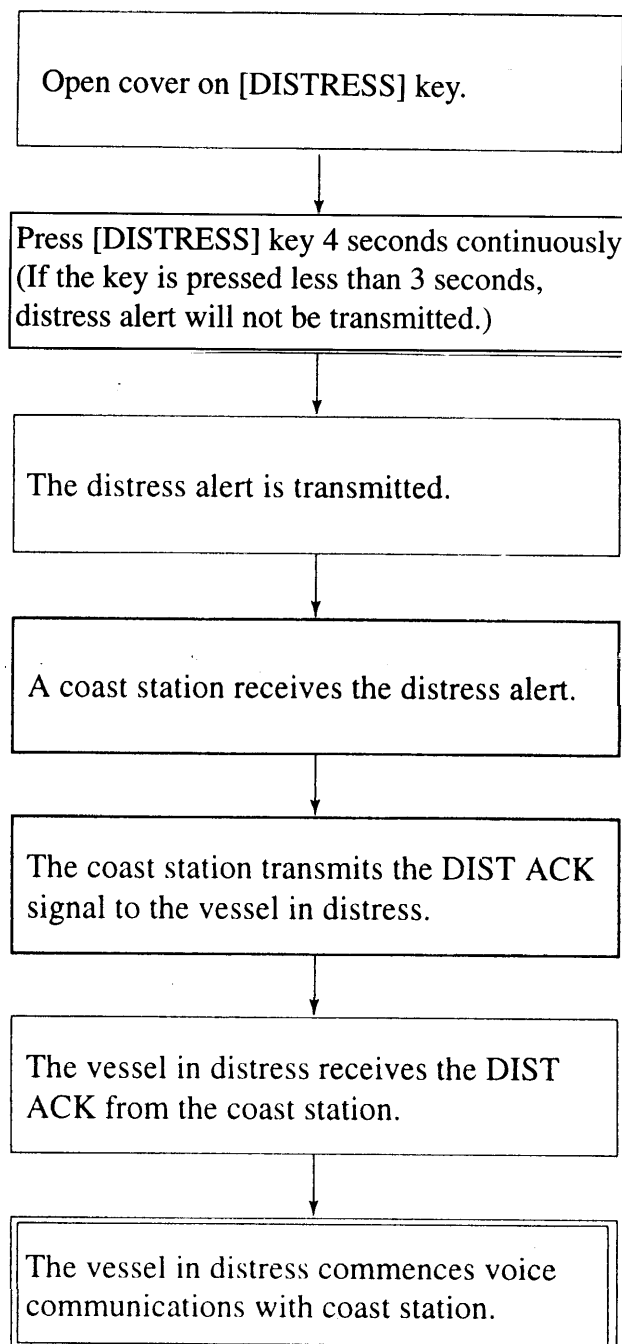

Transmitting the distress call

Nature of Distress	
[1]:	Fire, explosion
[2]:	Flooding
[3]:	Collision
[4]:	Grounding
[5]:	Listing, capsizing
[6]:	Sinking
[7]:	Disabled & adrift
[8]:	Abandoning
[0]:	Undesignated
[←]:	Piracy/armed robbery attack
[→]:	Man overboard

Watch VHF CH70
auto

- ① Open cover on [DISTRESS] key.
- ② Press [DISTRESS] key 4 seconds continuously.

DISTRESS CALL CH70
34° 40N 135° 20E at 15:20

Position/Time

To announce nature of distress, press appropriate key for nature of distress within 3 sec. after pressing the [DISTRESS] key. Continue pressing [DISTRESS] key 4 sec.

If no numeric key is pressed, distress alert is automatically transmitted.

DISTRESS CALL Nature?
UNDESIGNATED

Nature of Distress

If wrong nature of distress is input, enter correct nature within 3 seconds.

* Call in progress *
DISTRESS CALL CH70

(Transmitting)

Transmission time is about three seconds.

A coast station will transmit a DIST ACK signal to you to confirm the distress alert. Once you have received the DIST ACK signal, CH16 (Distress, Safety and Calling frequency) is automatically selected so that you may commence voice communications with the coast station. After the [DISTRESS] key has been pressed, no further operation of the radiotelephone is required until you have received the DIST ACK signal.

* Wait for dist ack *
Next CH70 3.7 min

(Waiting for distress acknowledge)

Counts down. If distress call is not acknowledged it is automatically retransmitted until acknowledged. (Do nothing until own ship receives DIST ACK.)

(continued on next page)

(from previous page)

* Received * DISTRESS ACK
ID : 001234567

ID of station (usually coast station)
which transmitted DIST ACK.

Commence voice communications with coast station on CH16.

1. Provide the following information to the coast station:

Distress call

- (1) Speak slowly and distinctly, "MAYDAY, MAYDAY, MAYDAY", pronounced as the French expression "m'aider".
- (2) This is;
- (3) The name of your vessel and call sign three times.

Then, begin the distress communications, which consists of:

Distress communications

- (1) Position in latitude and longitude;
- (2) The name of the distress;
- (3) The kind of assistance desired;
- (4) Any other information which might facilitate rescue, for example, length, color, and type of vessel, number of persons on board.

2. Indicate the end of message by saying "Over".

Some countries do not have sea area A. In this case "ACK" from the coast station does not arrive over DSC. A ship nearby will contact the vessel in distress over CH16. After transmitting the distress alert conduct voice distress communications as shown above.

3.2 Manual Entry of Ship's Position and Time

Entering data manually

If automatic position input is lost for one minute the message "EPFS error" appears. In this case, enter position manually as below.

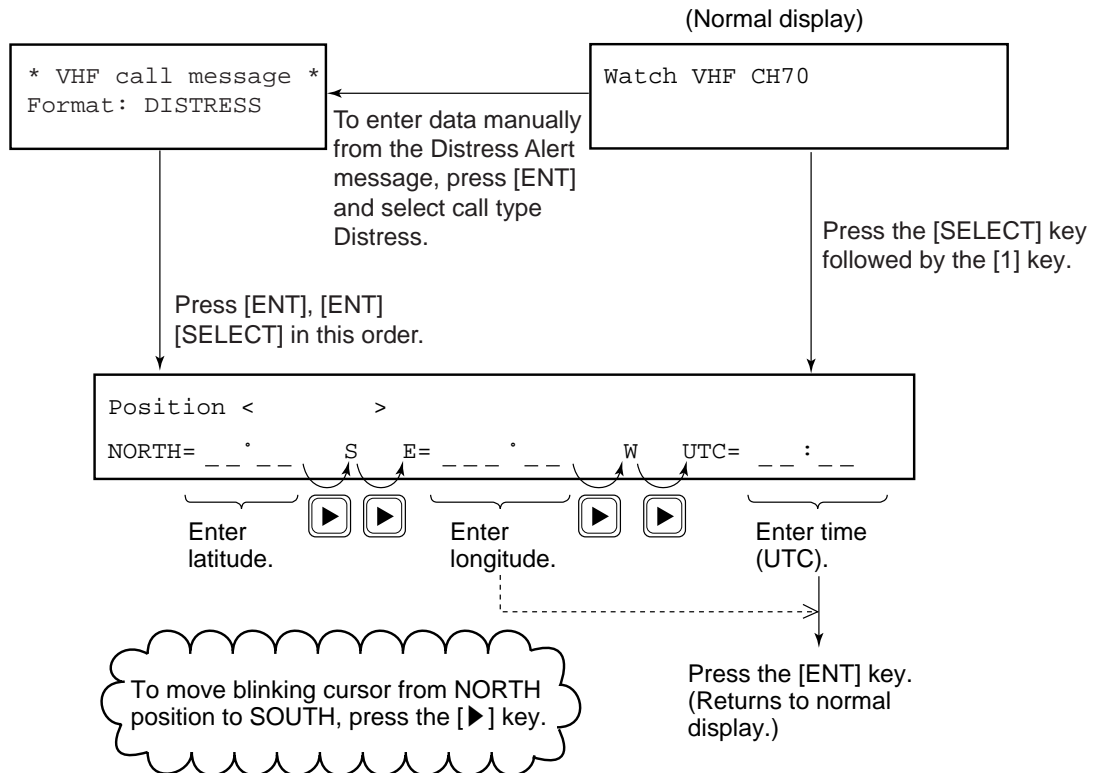

Note: If the manually entered position is not updated within four hours the buzzer sounds and the message "Warning: Update position!" appears on the screen. And if not updated within 23.5 hours the position entered is erased. Once automatic input of position is restored, cancel manually entered position as below.

Confirming Ship's Position and Time

Press and hold down the [1] (POSITION) key, ship's position and time are shown while the key is pressed.

Canceling manually entered data

To cancel the manually entered data, enter **9999** for the time and press the [ENT] key.

Note: Above procedure may also be used when you do not know your ship's position. This data is input as NO INFORMATION in POS&TIME in the DISTRESS ALERT MESSAGE.

3.3 Receiving Distress Alert from Other Ship

In no case is a ship permitted to transmit a DSC distress relay call on receipt of a DSC distress alert on VHF channel 70.

Conditions necessary for relaying distress alert:

- ① When the station in distress is not itself in a position to transmit the distress message, or
- ② When the master or person responsible for the vessel not in distress, or the person responsible for the coast station, considers that further help is necessary.

Procedure when in area A1

1. When the FM-8500 receives a distress alert from another vessel the upper two LEDs (Red) near the [ALARM STOP] key blink and the FM-8500 sounds the distress alarm.
2. Silence the alarm by pressing the [ALARM STOP] key.
3. Wait up to three minutes until the DIST ACK signal from a coast station is received. Be prepared to follow the instructions of the coast station.
4. If you do not receive the DIST ACK signal, follow the flow chart shown on the next page.

If further DSC alerts are received from the same source and the ship in distress is beyond doubt in the vicinity, a DSC acknowledgement may, after consultation with an RCC or Coast Station, be sent to terminate the call.

Note 1: An asterisk (*) in a received distress alert message indicates error or unknown at the location marked with the asterisk.

Note 2: Do not send DISK ACK in response to receipt of distress alert having a nature of distress of EPIRB emission.

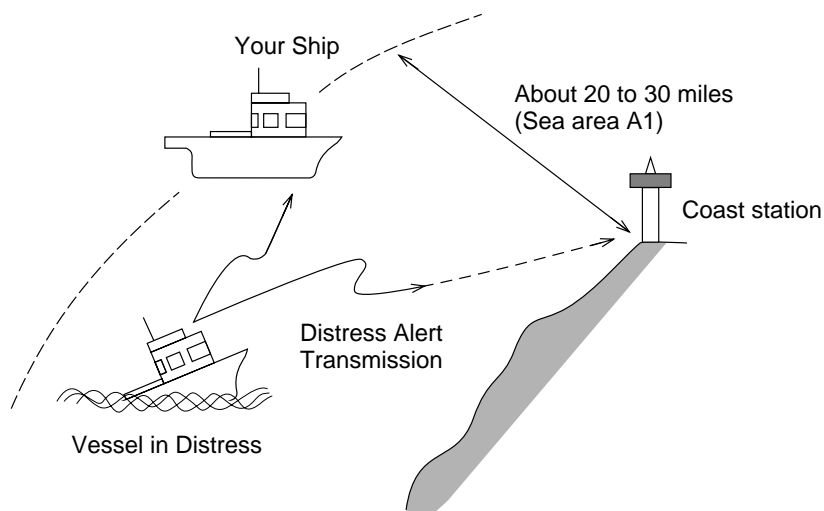

Flow chart - Action by ships upon reception of VHF DSC distress alert

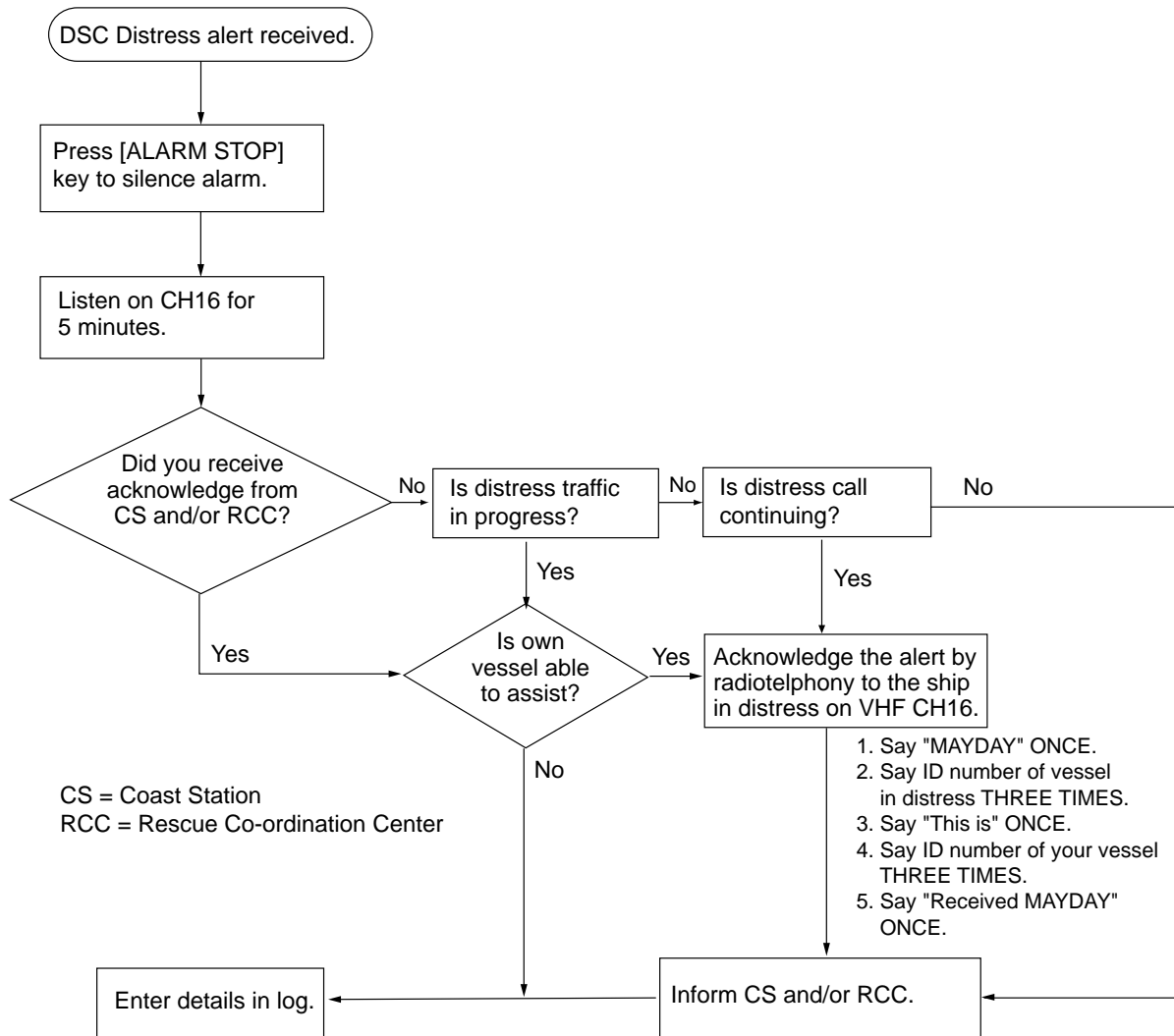

Transmitting DIST ACK over CH16

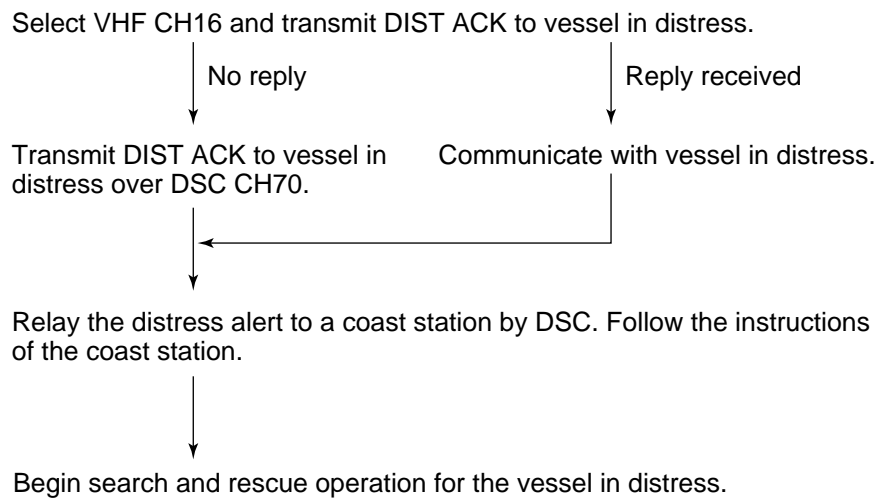

Transmitting DIST ACK

When you receive retransmission of distress alert from vessel in distress.

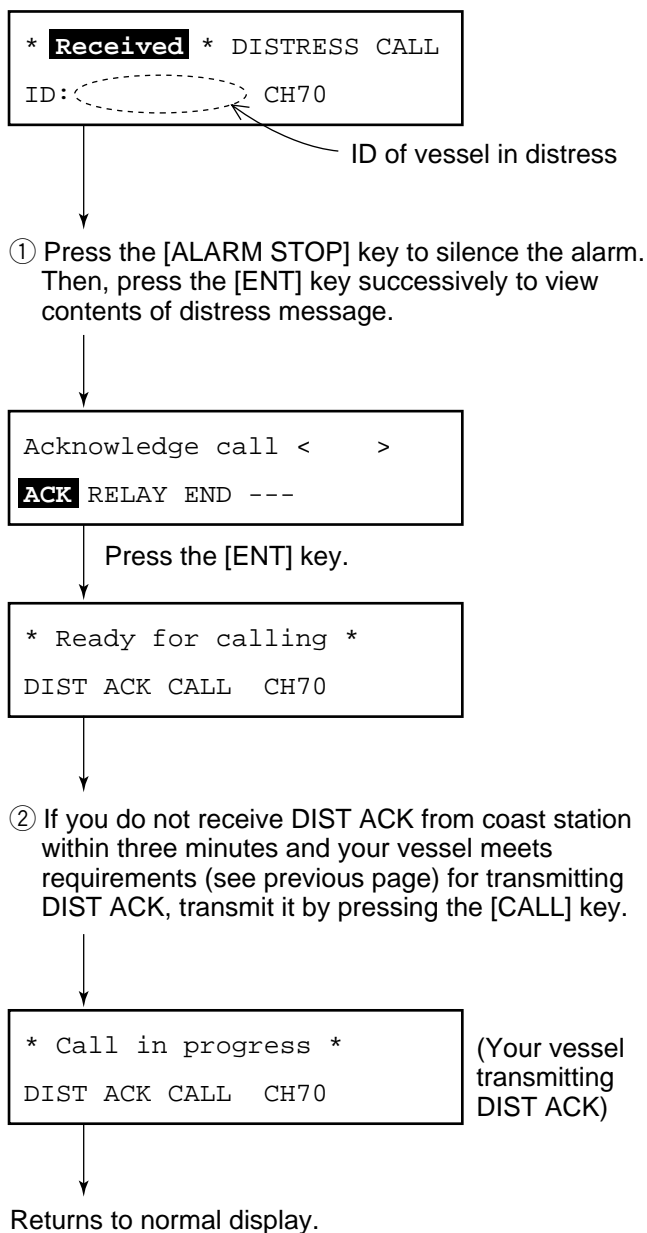

After transmitting DIST ACK

Begin search and rescue operations for the vessel in distress, communicating with the vessel over CH16 (automatically set) on the FM-8500. Relay distress alert to coast station by MF DSC. Finally, follow instruction of the coast station.

3.4 Distress Relay

General

If a vessel in distress is obviously near own ship and is not able to transmit the distress alert by itself, you can relay (transmit) the alert on behalf of the vessel in distress. You may relay a distress alert in the following conditions;

- ① When the station in distress is not itself in a position to transmit the distress message, or
- ② When the master or person responsible for the vessel not in distress, or the person responsible for the coast station, considers that further help is necessary.

However, DO NOT press the [DISTRESS] key; it is for use when own vessel is in distress.

Procedure

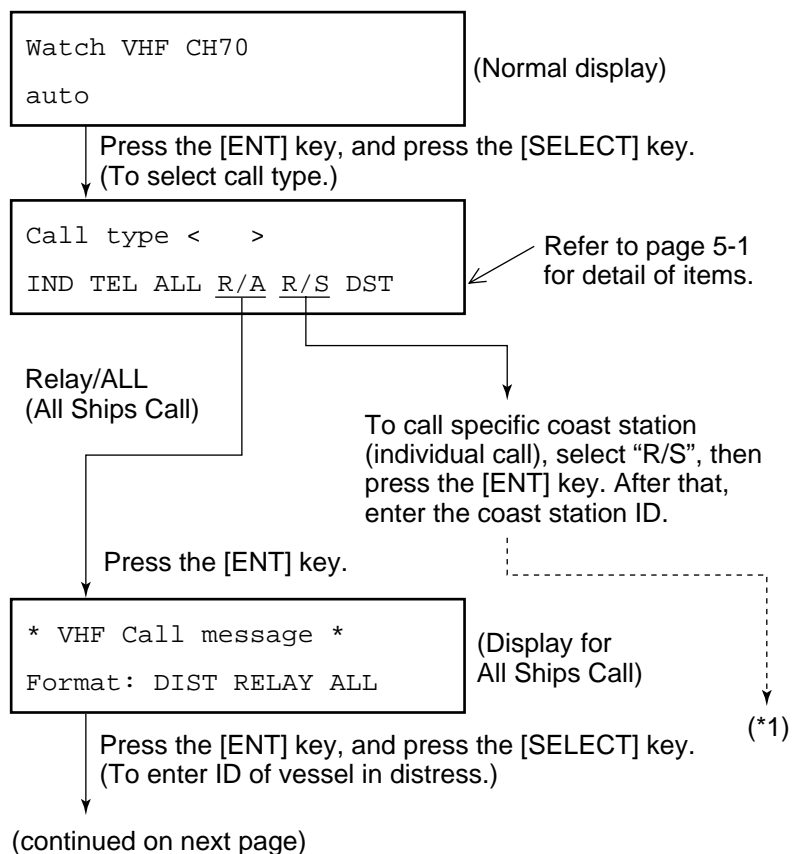

(from previous page)

Address < No inform >
input DIGITS=

(*1)

Enter ID of vessel in distress.
(If not know, enter "99 9" to set up for
"No information".)

Press the [ENT] key.

Nature of distress?
UNDESIGNATED DISTRESS

To designate nature of distress,
press the [SELECT] key.

If unknown, press the [ENT] key, and press the
[SELECT] key.
(To enter position of vessel in distress.)

Position < >
NORTH=

Manually enter position of vessel in distress, referring to page
3-4. If position is unknown enter "9999" (no information).

Press the [ENT] key, and press the [SELECT] key.
(To enter time.)

Distress UTC:
UTC?

Manually enter time.
("9999" means no information.)

Press the [ENT] key twice.

* Ready for calling *
DIST RELAY ALL CH70

Press the [CALL] key.

(continued on next page)

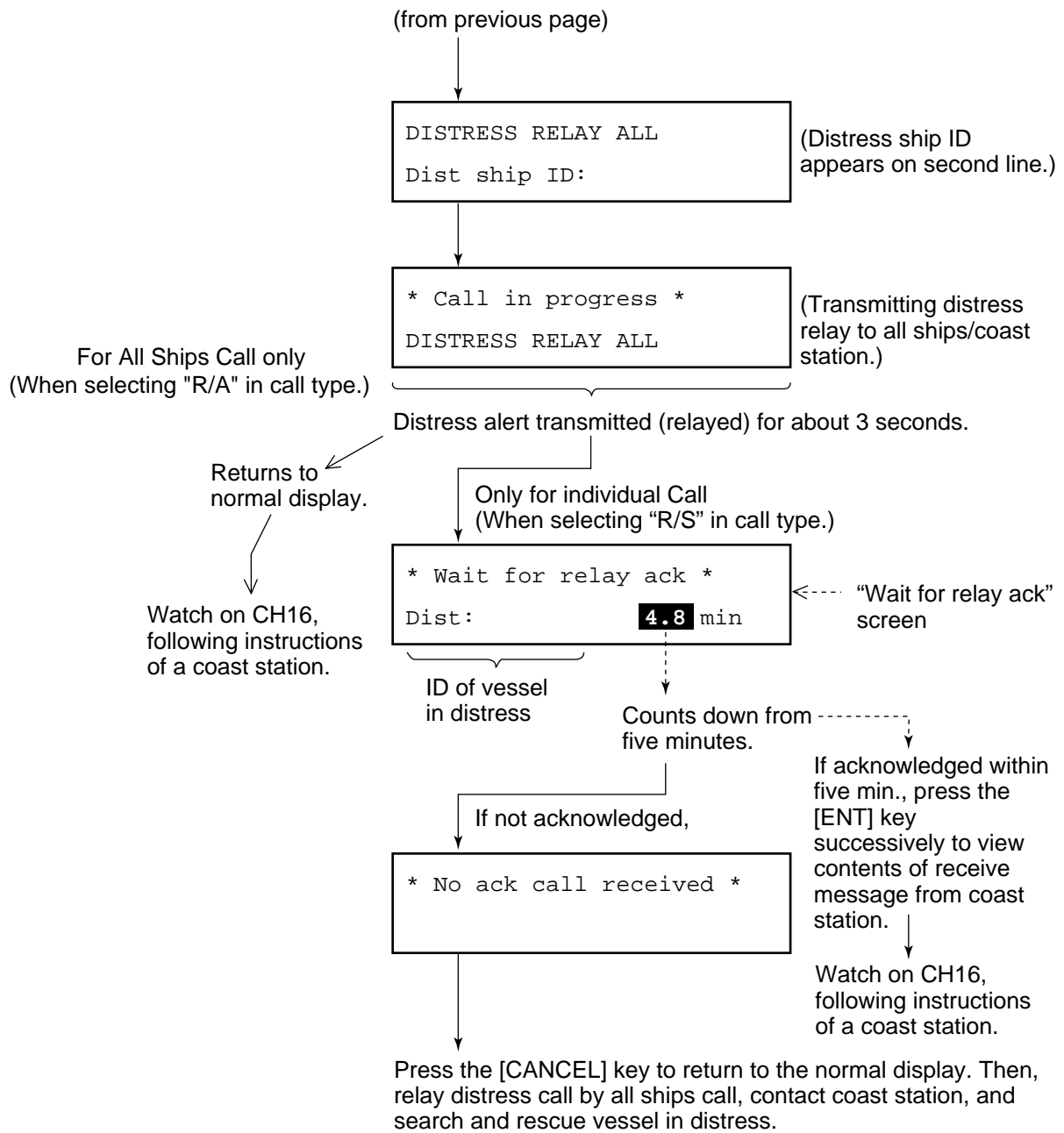

After relaying the alert, you must conduct search and rescue for the vessel in distress, following instructions of a coast station.

This page is intentionally left blank.

4. DSC Communication

4.1 Transmitting Individual Calls

General

The individual call is for sending message to a specific station. After transmitting message (called ACK RQ transmission), wait to receive the acknowledge back (ACK BQ) signal from receiving station. You should receive it within five minutes.

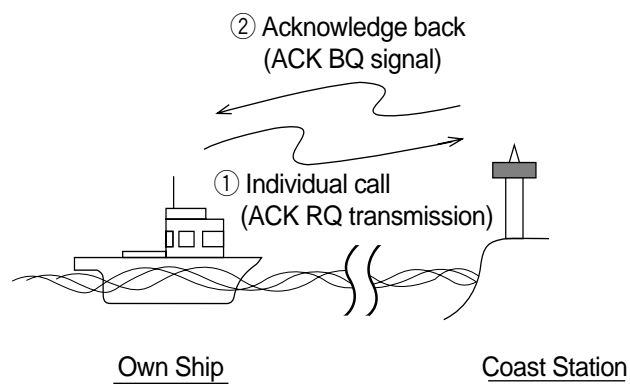
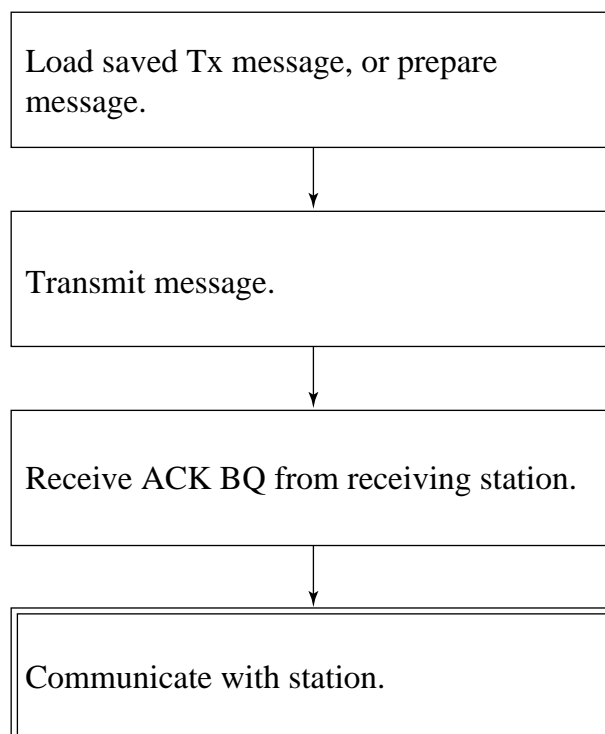

Figure 4-1 Individual Call

General procedure



Detailed procedure

Prepare and transmit a message as follows.

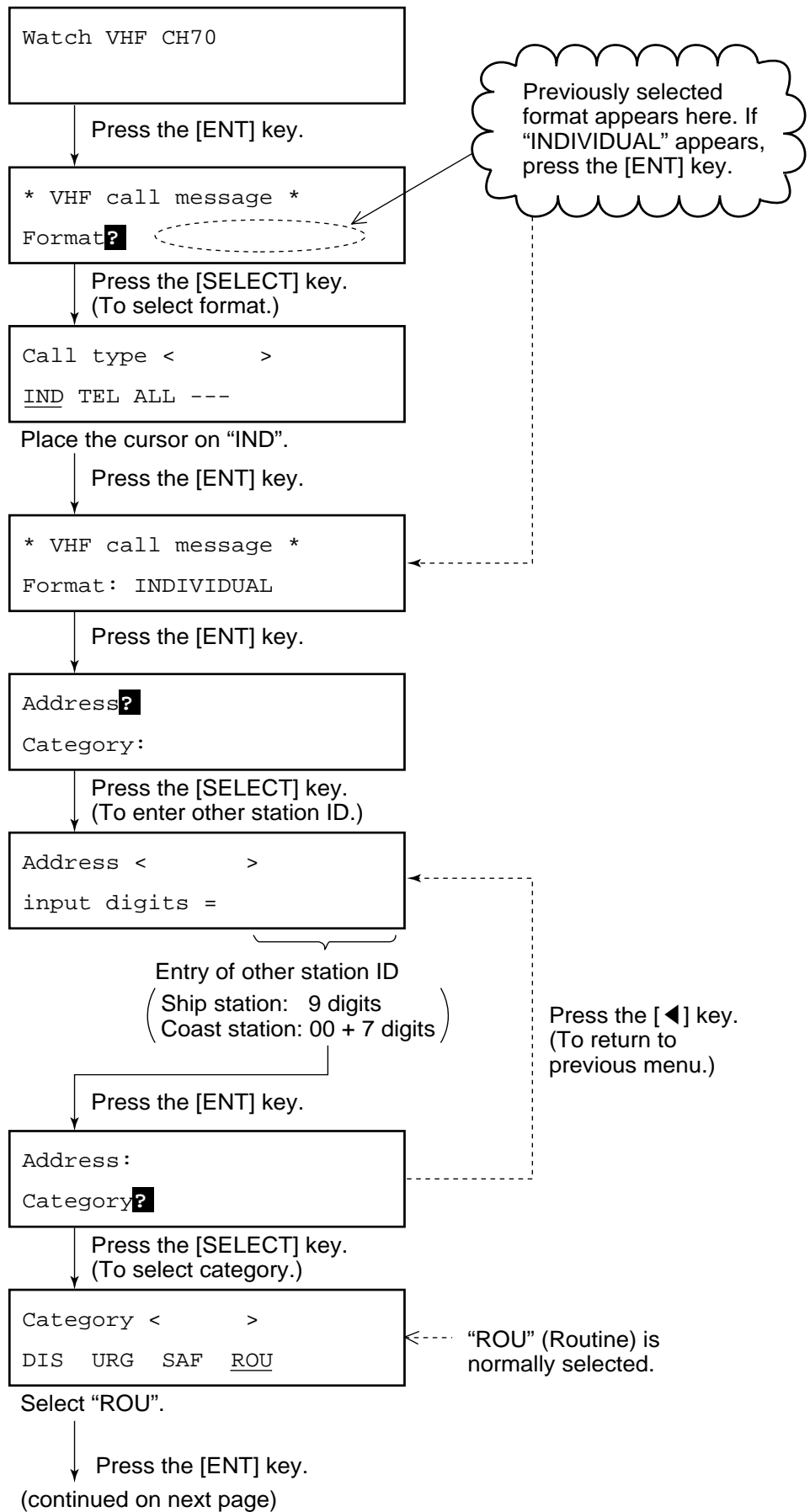

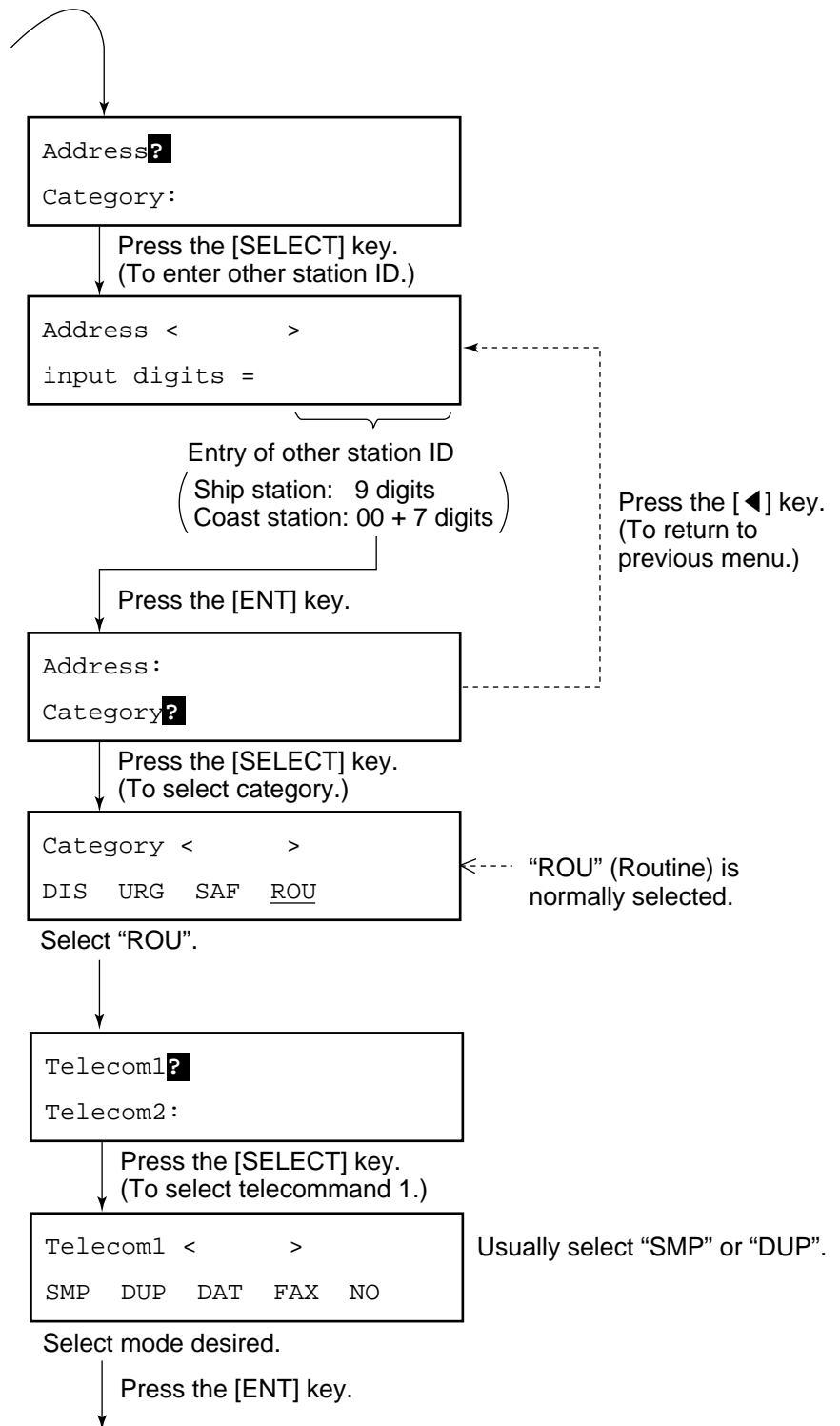

(From previous page.)



After receiving the ACK BQ signal, do the following:

* Wait for ack BQ *
Next CH70

When the ACK BQ signal is received;

* **Received** * ACK BQ
ID: ROUTINE

Received station ID

① Alarm sounds. To silence, press the [ALARM STOP] key.

② If **ABLE** appears, communicate with other station over the VHF.

If **UNABLE** appears, prepare a message with different proposal and transmit it by pressing the [CALL] key. Repeat until proposal is mutually accepted.

③ If you want to view contents of receive message, press the [ENT] key successively.

Returns to normal display.

ABLE: Receiving station accepts working channel proposed by your ship.
UNABLE: "16" is displayed when other ship rejected working channel proposed by your ship. If coast station was called, however, the LCD shows "QUEUE INDICATION," meaning the coast station is busy. Wait on channel designated; the coast station will contact you.

4.2 Receiving Individual Call (ACK RQ)

General

When an individual call is received, the FM-8500 responds to the call depending on the setting of automatic acknowledge (AUTO ACK) function:

- AUTO ACK: ON (“auto” appears.)

The DSC transmits the acknowledge back (ACK BQ) signal automatically.

- AUTO ACK: OFF (“manual” appears.)

Verify contents of receive message by pressing the [ENT] key successively, then manually transmit the ACK BQ signal by pressing the [CALL] key.

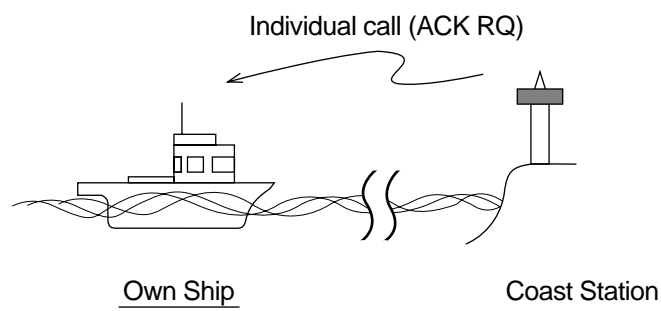
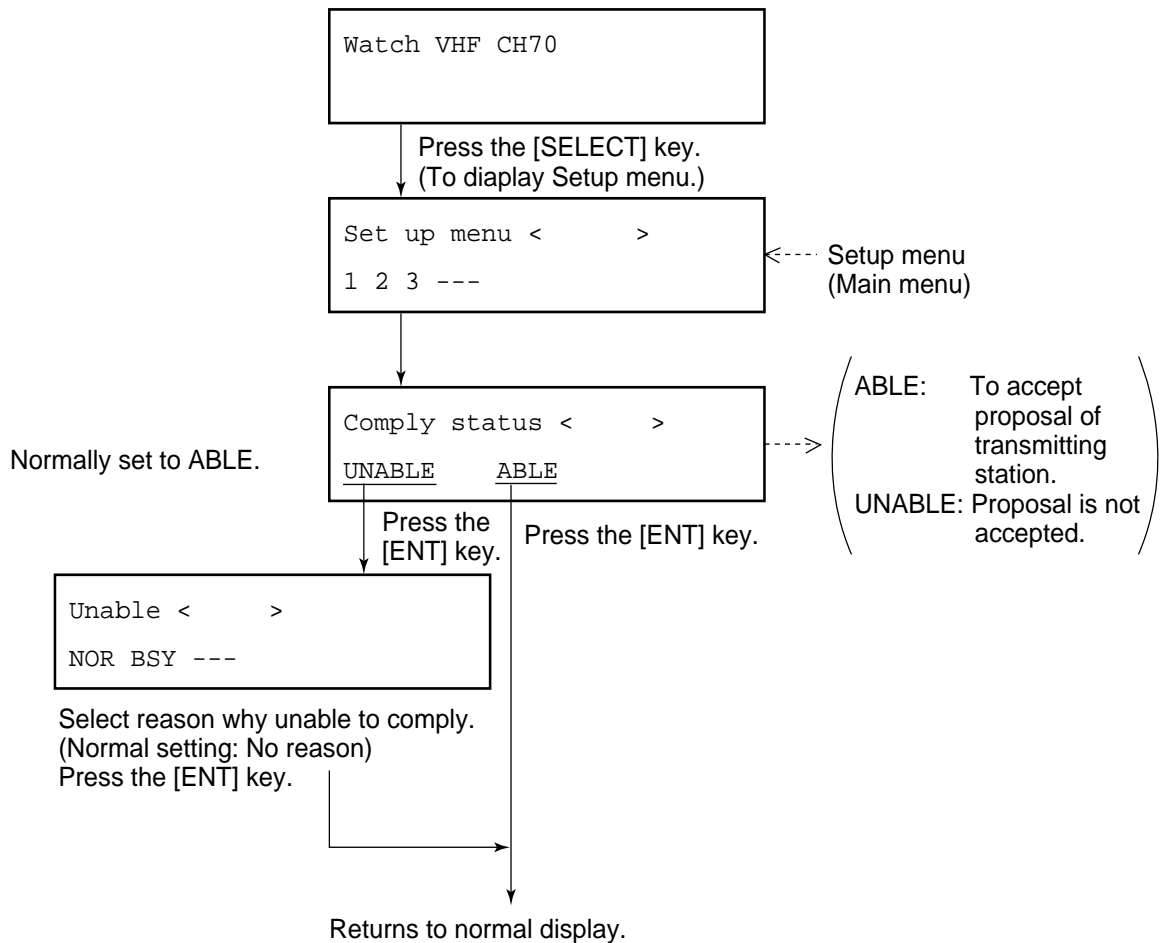

Figure 4-2 Receiving "Individual Call"

Setting of “ABLE” or “UNABLE”

When AUTO ACK function is ON, you can select either “able” or “unable” (to comply) for proposal from other station. See the next page.



Receiving individual call message (ACK RQ) with AUTO ACK On

The FM-8500 sends the ACK BQ signal automatically.

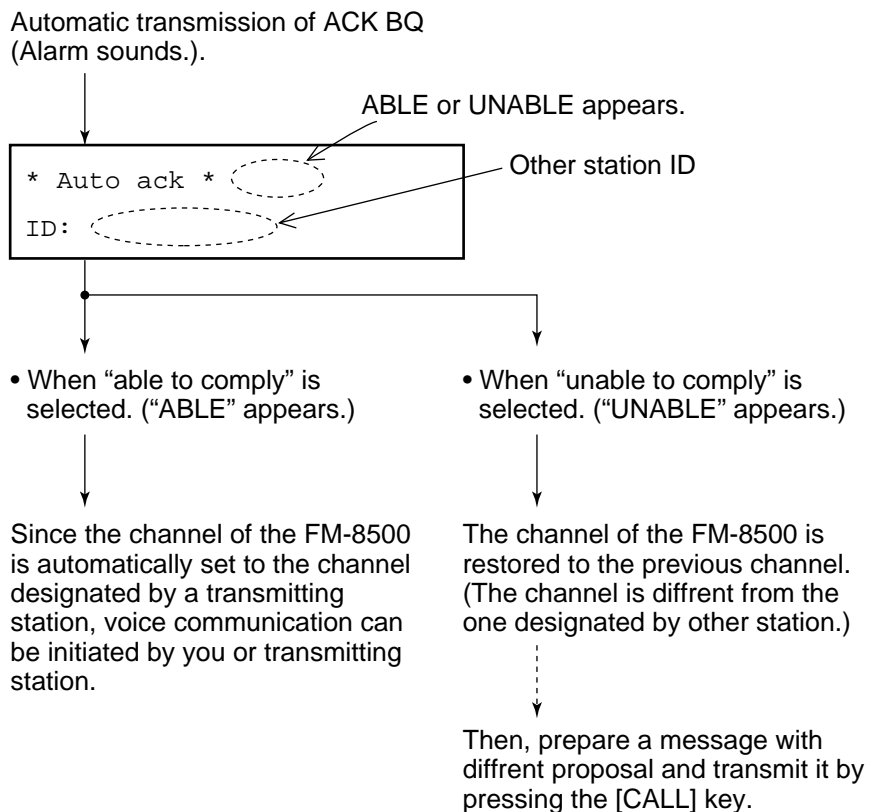

Receiving ACK RQ with AUTO ACK Off

After verifying contents of receive message, manually transmit the ACK BQ signal by pressing the [CALL] key within five minutes. If the signal is transmitted more than five minutes after reception of ACK RQ signal, it is treated as an ACK RQ signal rather than ACK BQ.

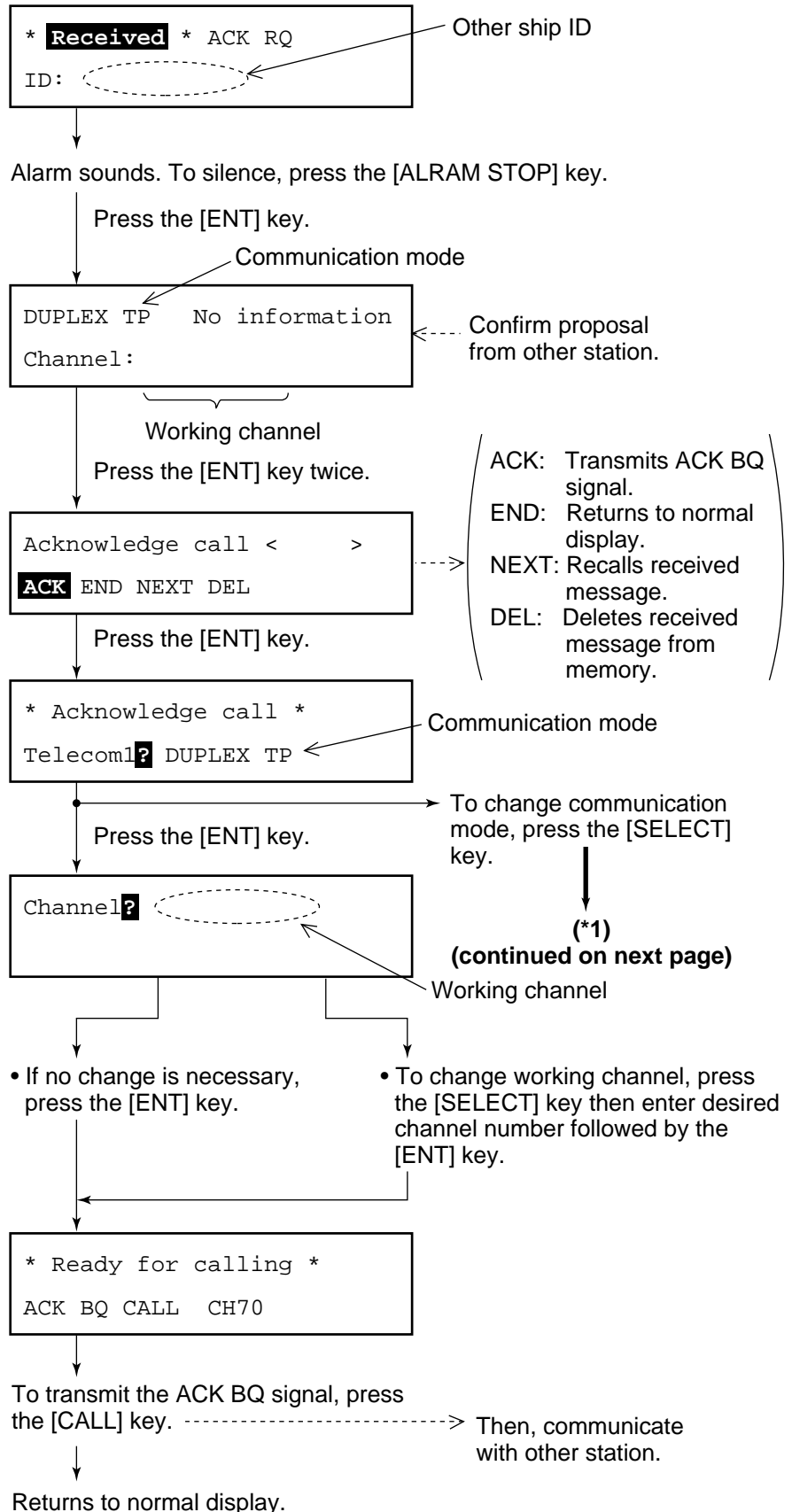

(*1)
(from previous page)

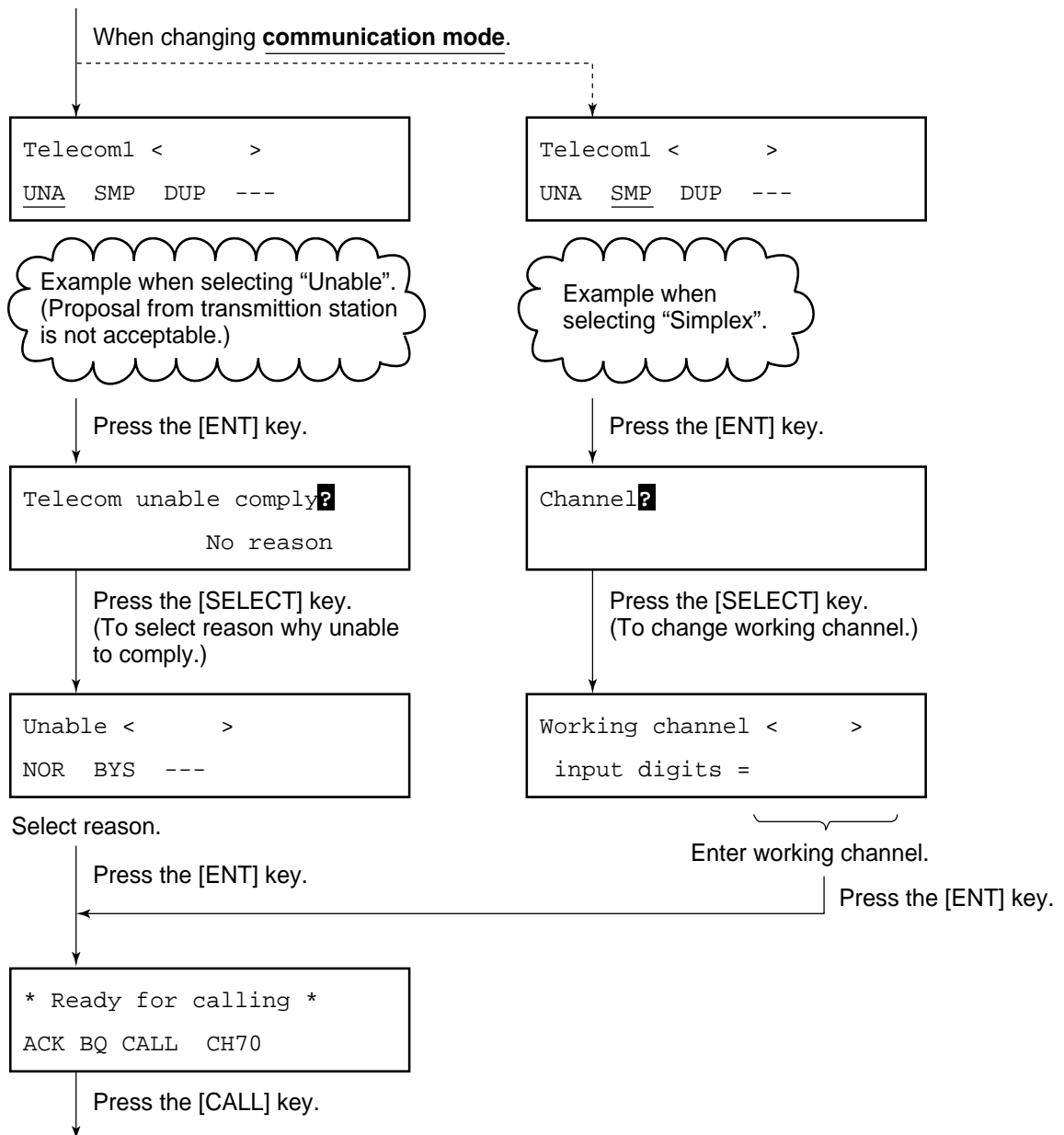

If a different communication mode is selected as shown above, "ACK BQ" call is first transmitted and "ACK RQ" call automatically continues. This means the message proposed here is transmitted as ACK RQ signal (not ACK BQ). Finally the "Wait for ACK BQ" screen appears.

4.3 Transmitting All Ships Calls

When to use All Ships Call

The All Ships Call is used to transmit important ship's safety message, safety of life at sea message or meteorological warning.

After transmitting message, you can communicate by voice over the FM-8500.

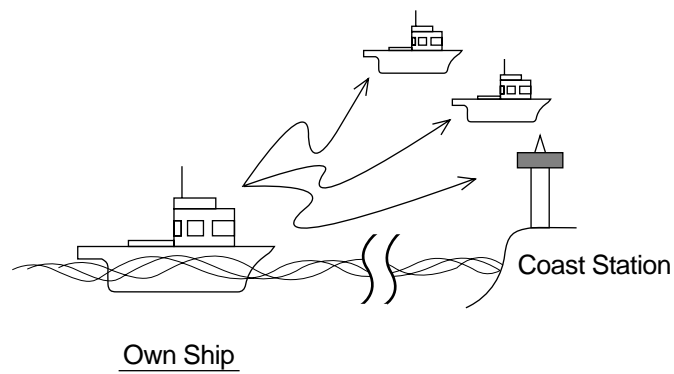
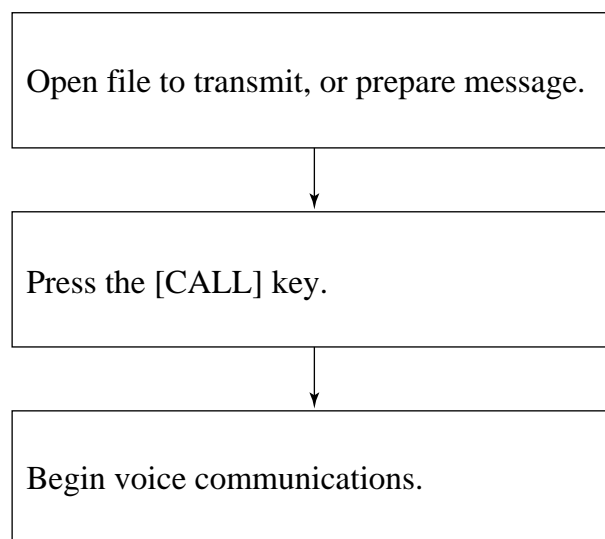

Figure 4-3 All Ships Call

General procedure



The procedure for voice communication is shown on the next page.

Detailed procedure

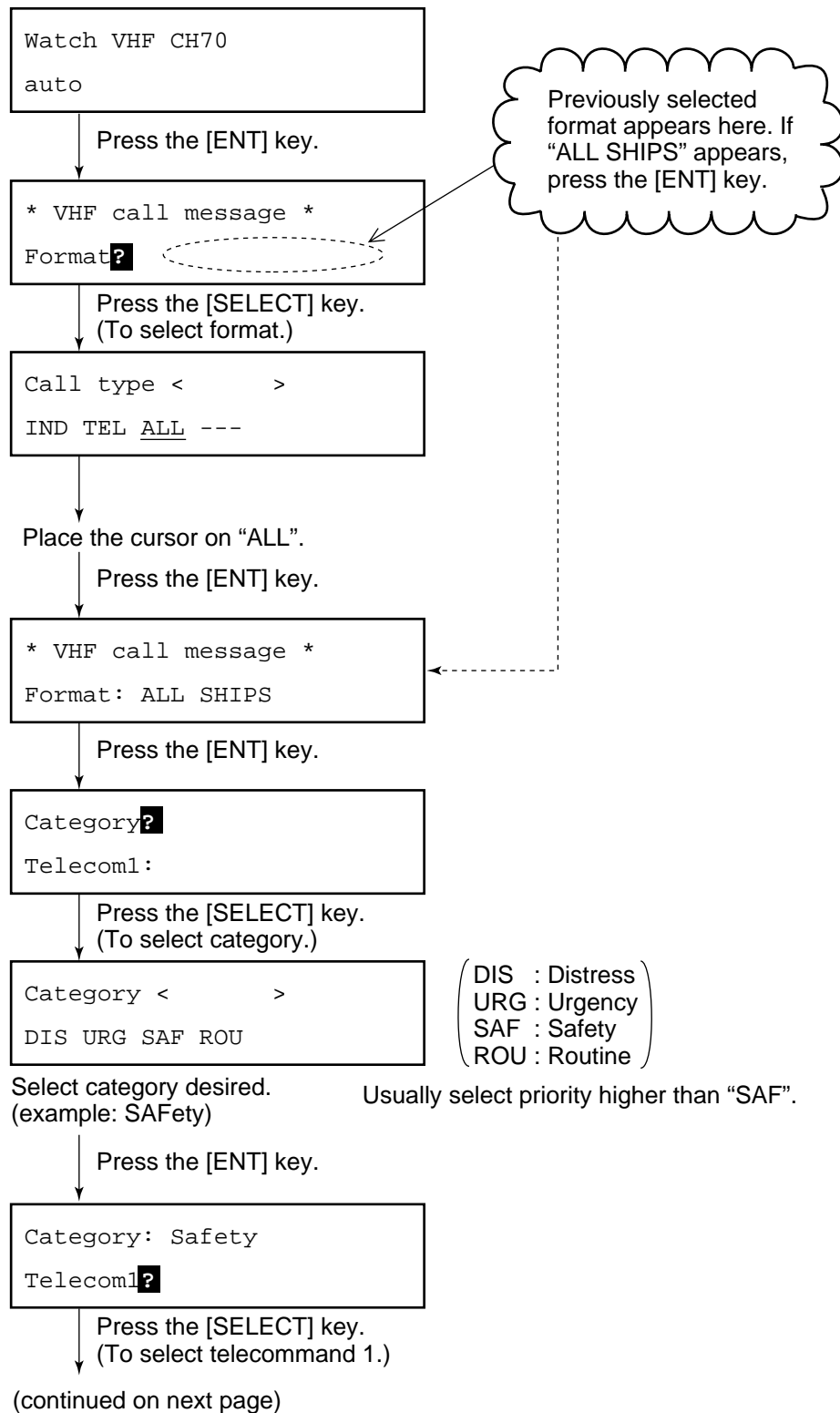

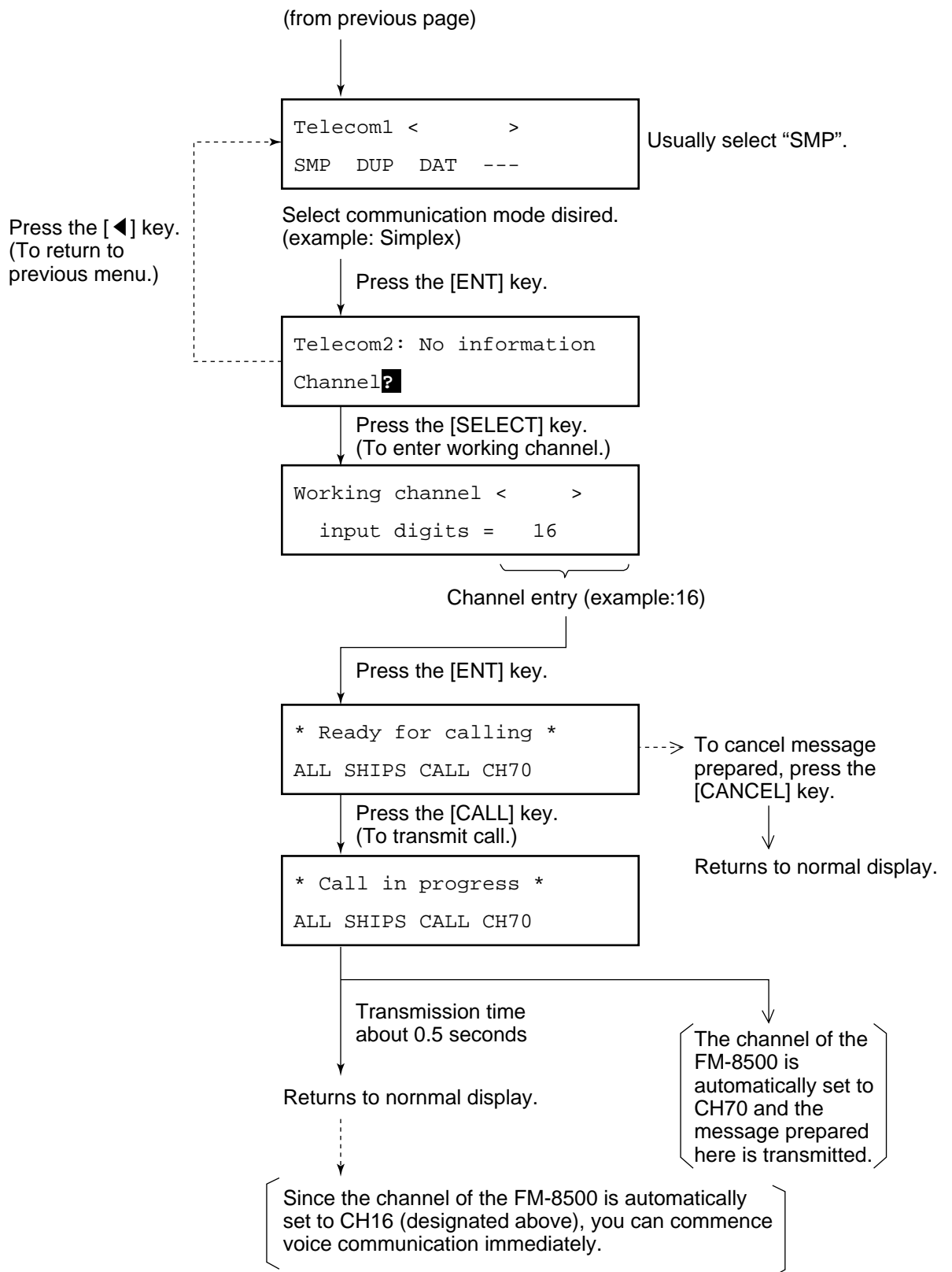

4.4 Receiving All Ships Calls

General

When an all ship's call is received while conducting voice communications, press [2] (AUTO ACK) to switch to VHF channel. The all ship's call, transmitted by coast station or ship station, provides navigation and weather alerts and emergency information.

Status of FM-8500

Handset status	When an all ship's call is received
On hook (*)	<ol style="list-style-type: none">1. Equipment automatically switches to working channel.2. Caller's voice can be heard.
Off hook (*)	<ol style="list-style-type: none">1. Alarm sounds.2. Press [2](AUTO ACK) key to switch to working channel.3. Caller's voice can be heard.

* On hook: Handset hung in hook.
Off hook: Handset picked up.

Procedure for on hook status

Basic procedure

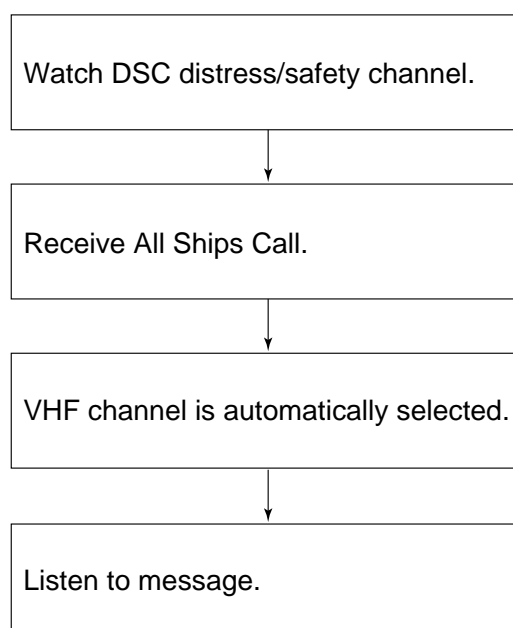

Detailed procedure

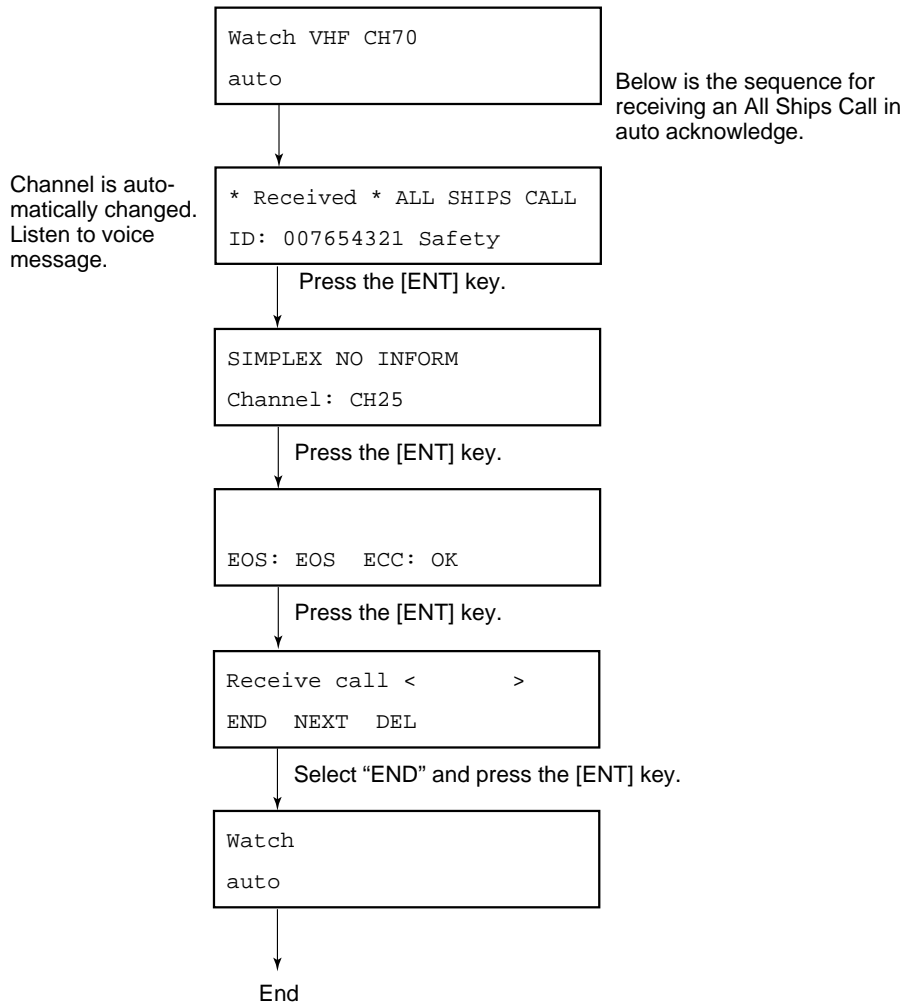

Procedure for off hook status

Basic procedure

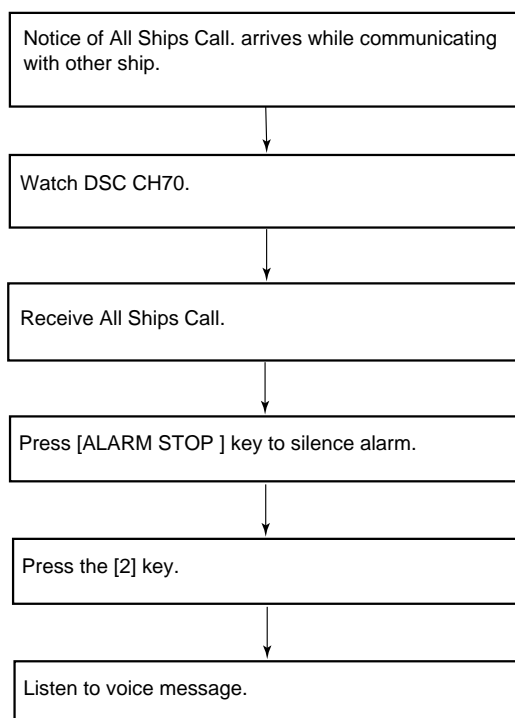

Detailed procedure

Below is the sequence for manually acknowledging an All Ships Call when the handset is off hook.

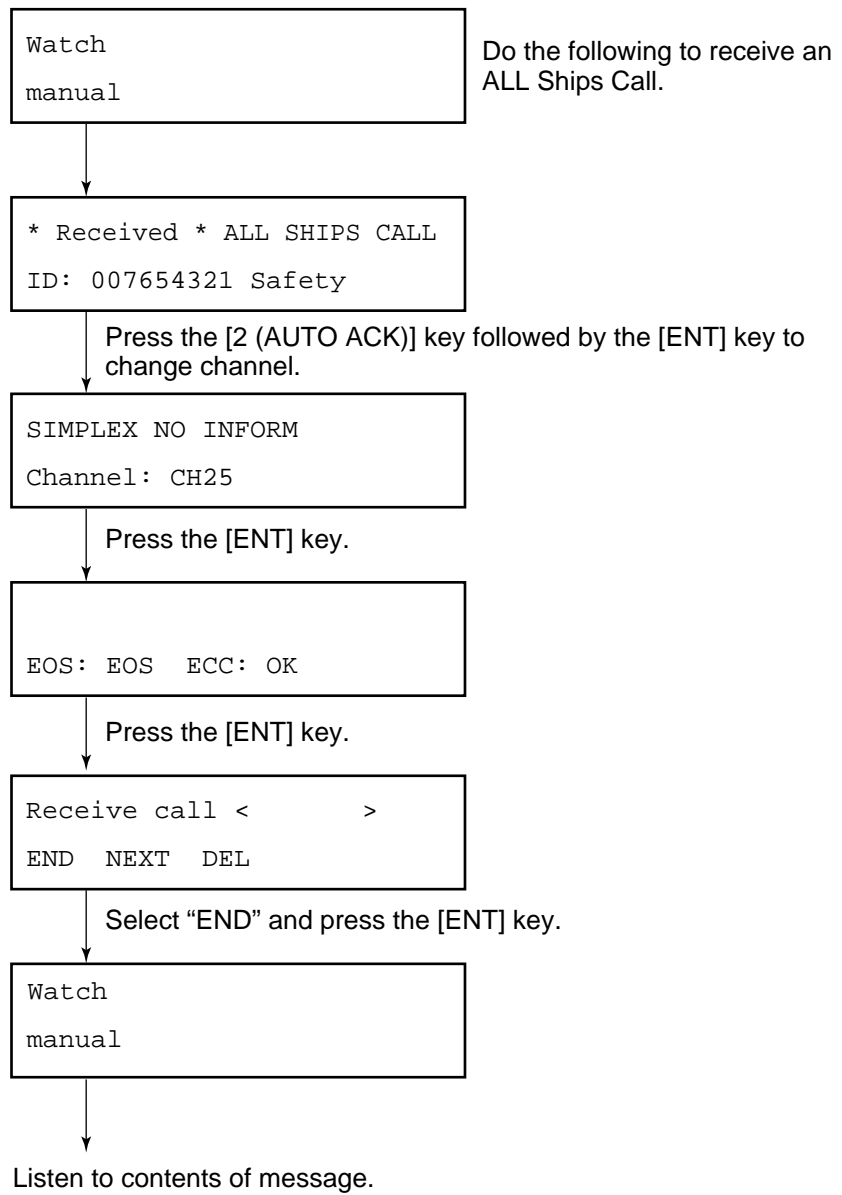

4.5 Creating and Saving Transmit Messages

General

There are two ways to prepare and transmit a message:

1. Prepare a message for immediate transmission. (Refer to page 4-1.)
2. Prepare a message and store it for later transmission.

You can save up to 59 transmit messages (excluding distress messages) to the memory. These are numbered 01 to 59.

How to create transmit messages

At the normal display, press the [SELECT] key and the [7 (FILE)] key. Select "MESSAGE" and press the [ENT] key. Prepare message as follows:

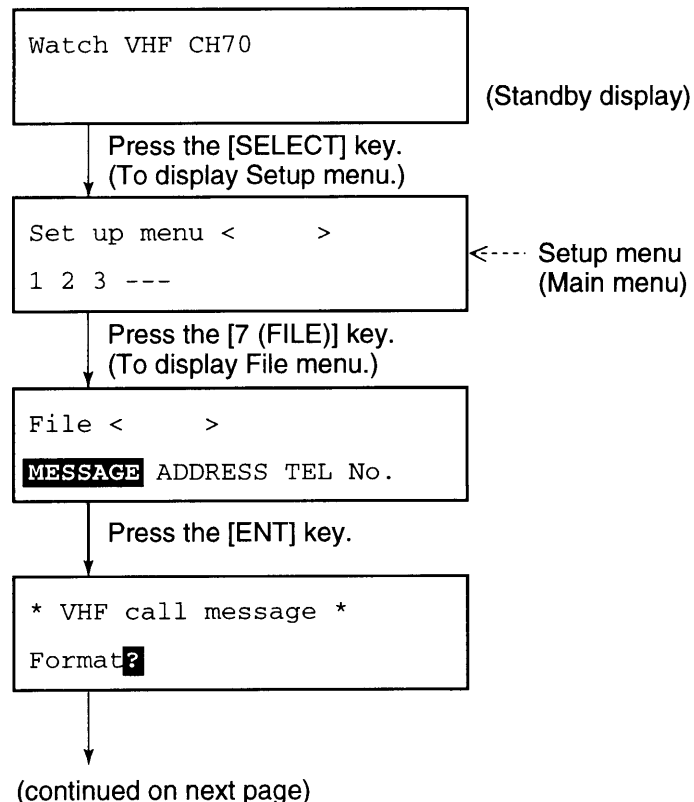

(from previous page)

Prepare a message by referring to page 4-9 (All Ships) and page 4-1 (individual).

* Ready for filing *

Press the [ENT] key.
(To select file number under which to save message.)

Call message < >
01/59:

File No.
(blinking)

Press the [ENT] key.
(To assign file name.)

To select a different file number, use the arrow keys.
(▶:Up, ◀:Down)

Name < >
END A B C D ----- R →

To scroll screen, press the [▶] key.

Assign a file name (max. 16 characters) by the arrow keys, the [ENT] key and ten keys.

Example File Name: A1

1. Place the cursor on "A" with the arrow keys and press the [ENT] key. (For alphabet always press the [ENT] key after selection.)
2. Press the [1] key.

To change specific character, press the [SELECT] key and ...

▶: Moves upper cursor rightward every pressing.
◀: Moves upper cursor leftward every pressing.

Name < A1 >
END A B C D ---

To change entire name, press the [CANCEL] key.

Press the [◀] key to place the lower cursor on "END".

Press the [ENT] key.

Using the example above, the unit saves the transmit message to the memory under file number 1, file name "A1".

Next file memory < >
END NEXT

To prepare another message;

Press the [ENT] key.

Press the [ENT] key.

Returns to normal display.

* VHF call message M *
Format?

4.6 Writing Over Files

General

You may write over unnecessary files. Simply prepare a message and store it under file number of unnecessary file.

Procedure

Example: You want to write over file saved under file number 01.

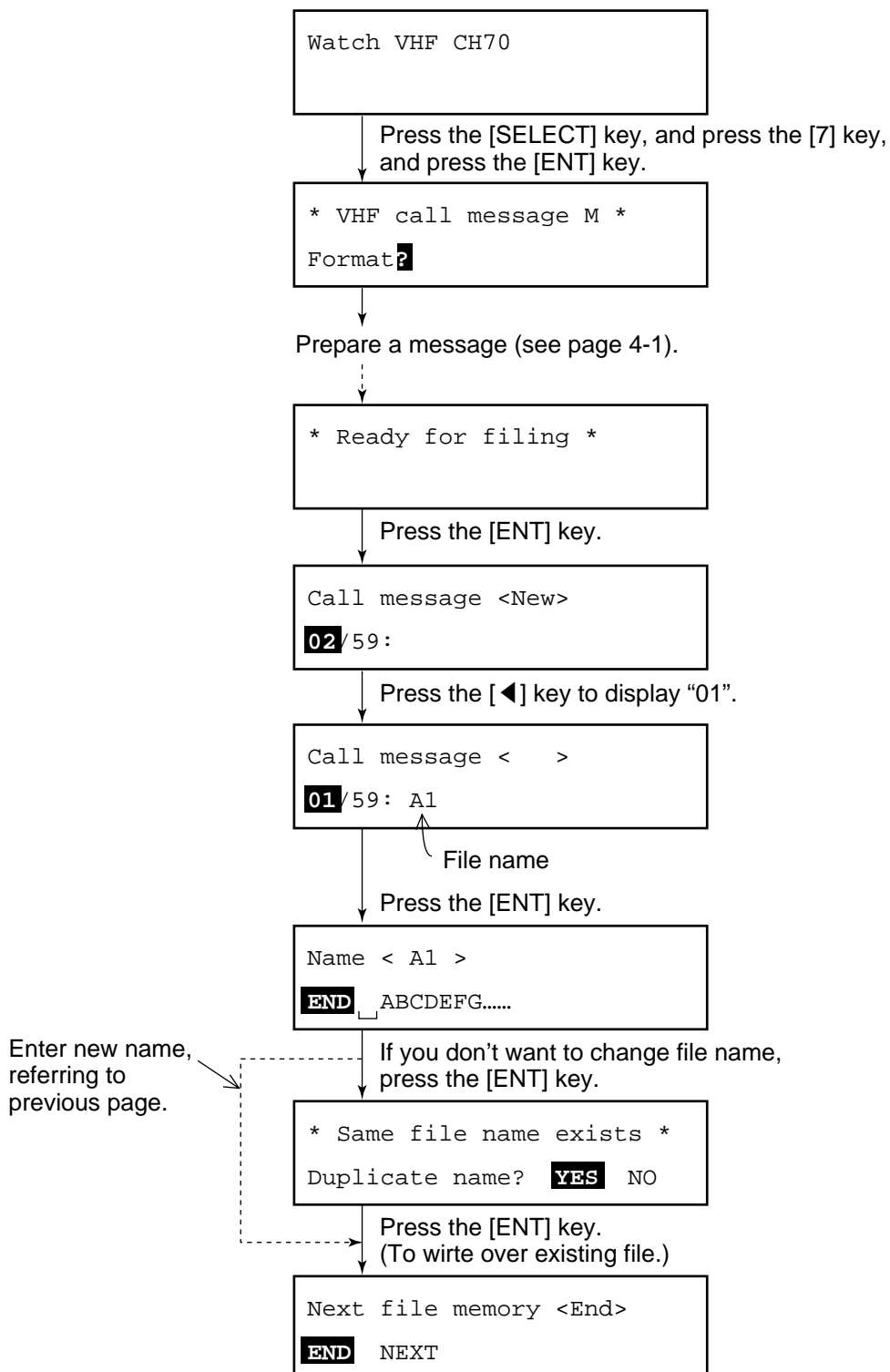

4.7 Retrieving, Transmitting Files

Retrieving a file

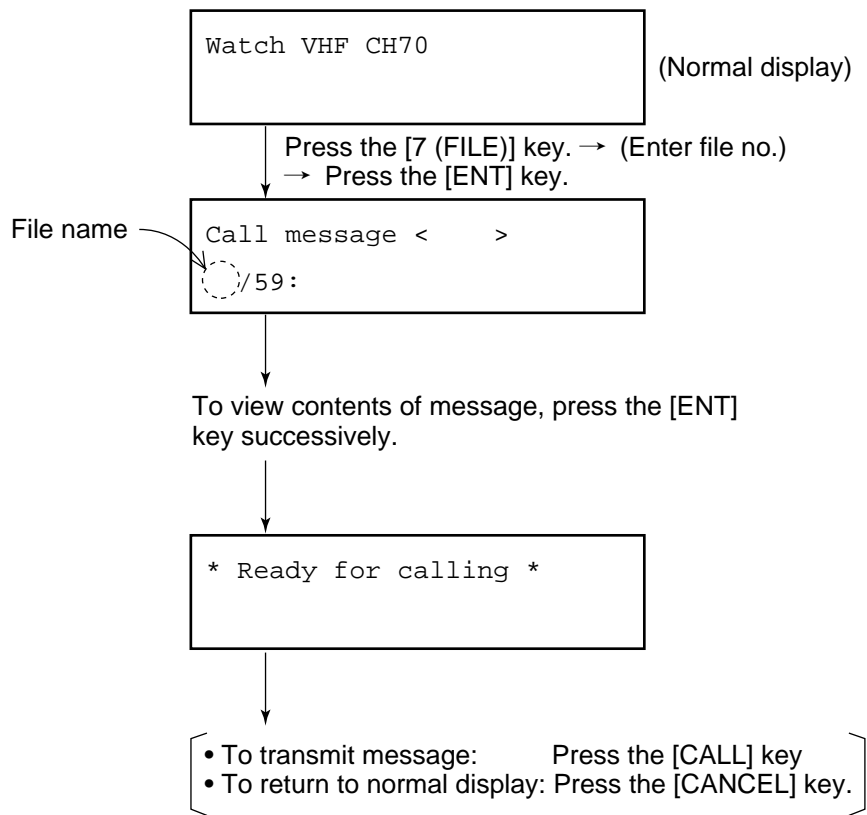

Transmitting a file

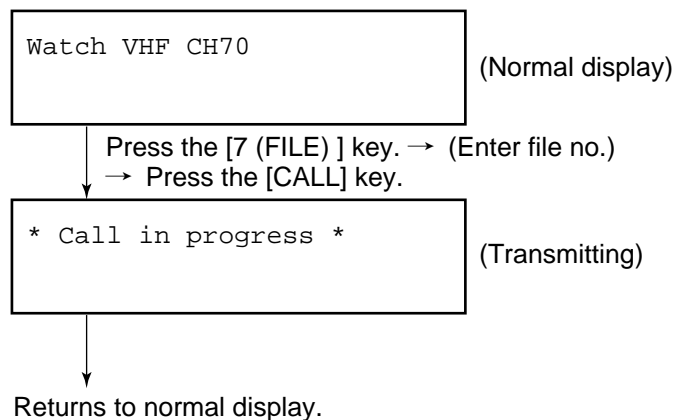

4.8 Transmit/Receive Message Memory

General

The transmit message memory stores **up to 50 transmitted messages** (numbered 1 to 50) on a first-in, first-out basis. This means each time you save a transmitted message it is filed as log no. 1 and the log no. of all previously stored transmit messages changes by one. When the memory is full the oldest file is deleted.

Retrieving a transmit message

Press the [9 (XMTD)] key at the normal display.

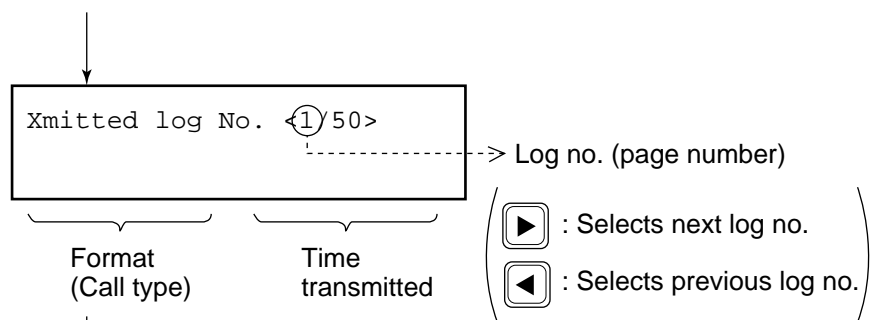

To view contents of message, press the [ENT] key successively.

Transmitting retrieved message

You can transmit a retrieved message as follows.

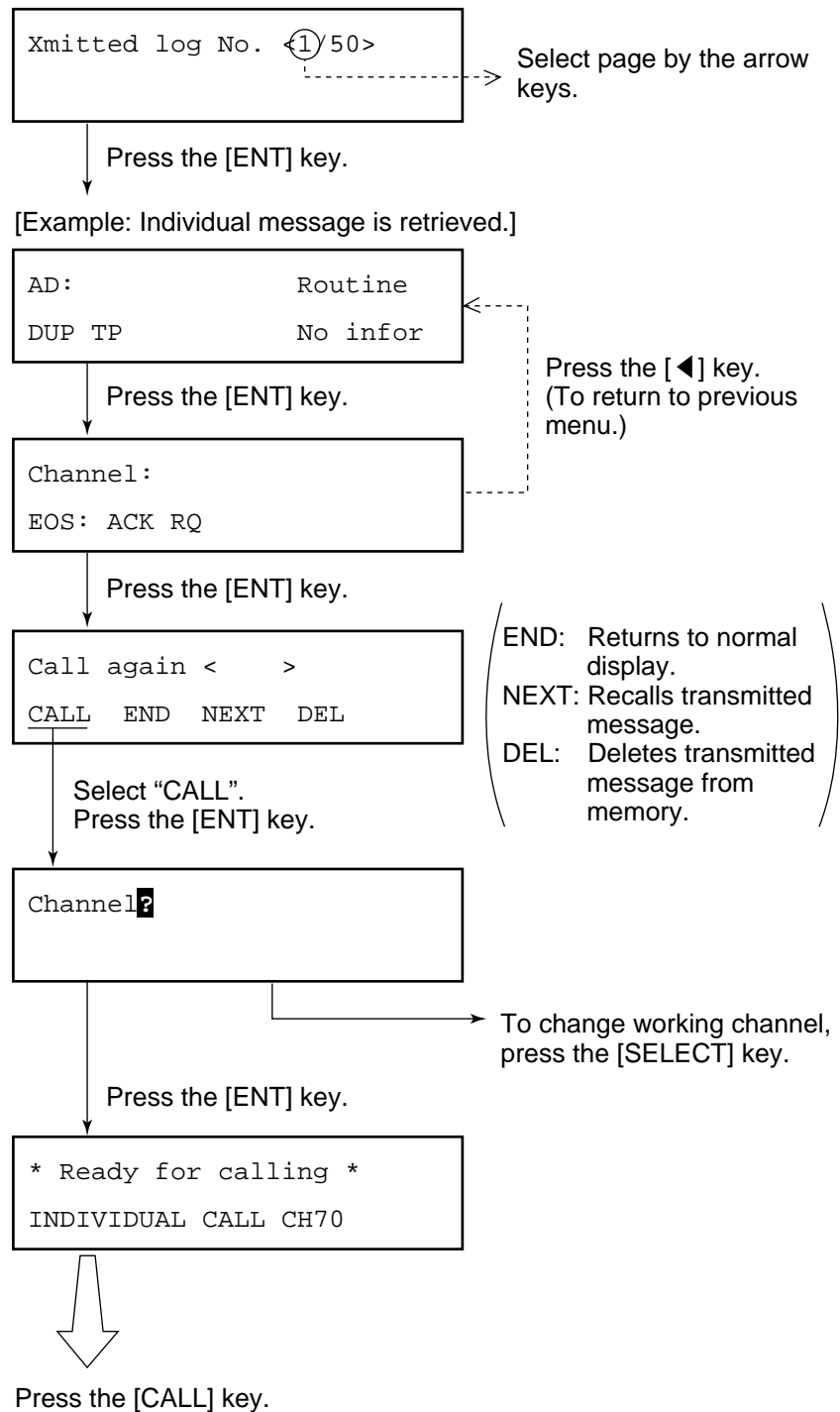

Receive message memory

All received messages are automatically saved to the memory and filed according to category, DISTRESS or ORDINARY. The receive message memory can store **up to 50 messages** (numbered 1 to 50) of each category on a first-in, first-out basis. This means each time the unit receives a message it saves it as log no.1 and changes the log no. of all previously received messages by one. When the memory is full the oldest file is deleted.

Retrieving a receive message

Press the [8 (RCVD)] key at normal display.

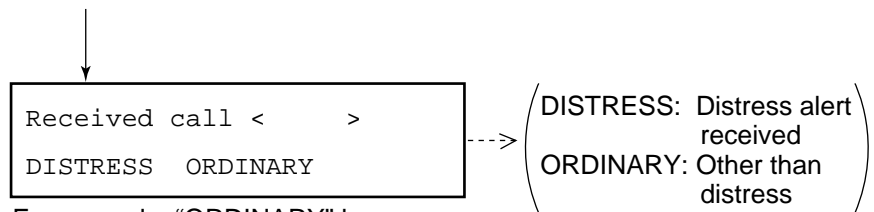

For example, "ORDINARY" log;

Press the [ENT] key.

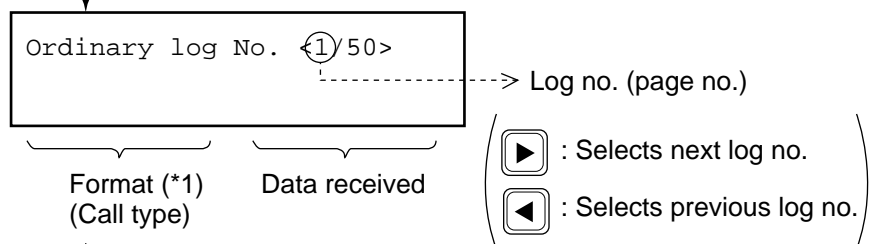

To view contents of message, press the [ENT] key successively.

(*1): If own ship did not transmit "ACK BQ" (acknowledge back) signal a blinking sharp symbol (#) appears at head of Format.

Transmitting retrieved message

You can send the acknowledged call (DIST ACK or ACK BQ) under certain conditions after retrieving a received message. Refer to page 3-5 for transmitting the DIST ACK signal.

Example: Transmit acknowledge back (ACK BQ) signal in response to an individual call (Refer to page 4-5.)

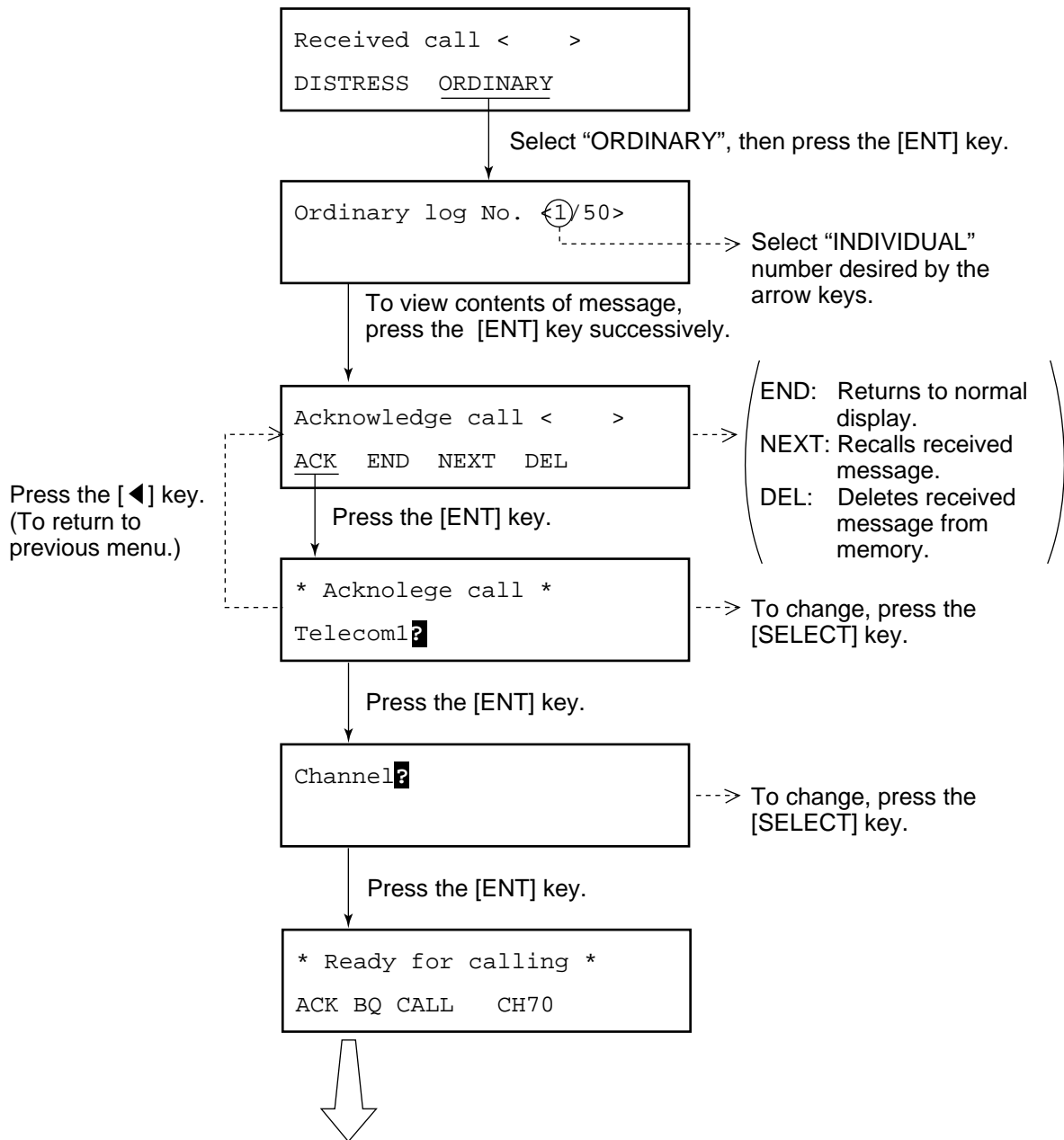

Press the [CALL] key to transmit the ACK BQ signal.

NOTE: If the signal transmitted more than five minutes after reception of ACK RQ signal, it is treated as an ACK RQ signal rather than ACK BQ. Finally the "Wait for ACK BQ" screen appears.

5. Other Calling Types and Other Functions

5.1 Other Calling Types

General

The FM-8500 provides 12 calling types. Of these, individual, all ships and distress were discussed in previous chapters. This section describes the other types of calls available. The procedure for preparing and transmitting other calls is the same as that for individual and all ships calls: Select type of call, prepare message and transmit it by pressing the [CALL] key.

Selection of calling type

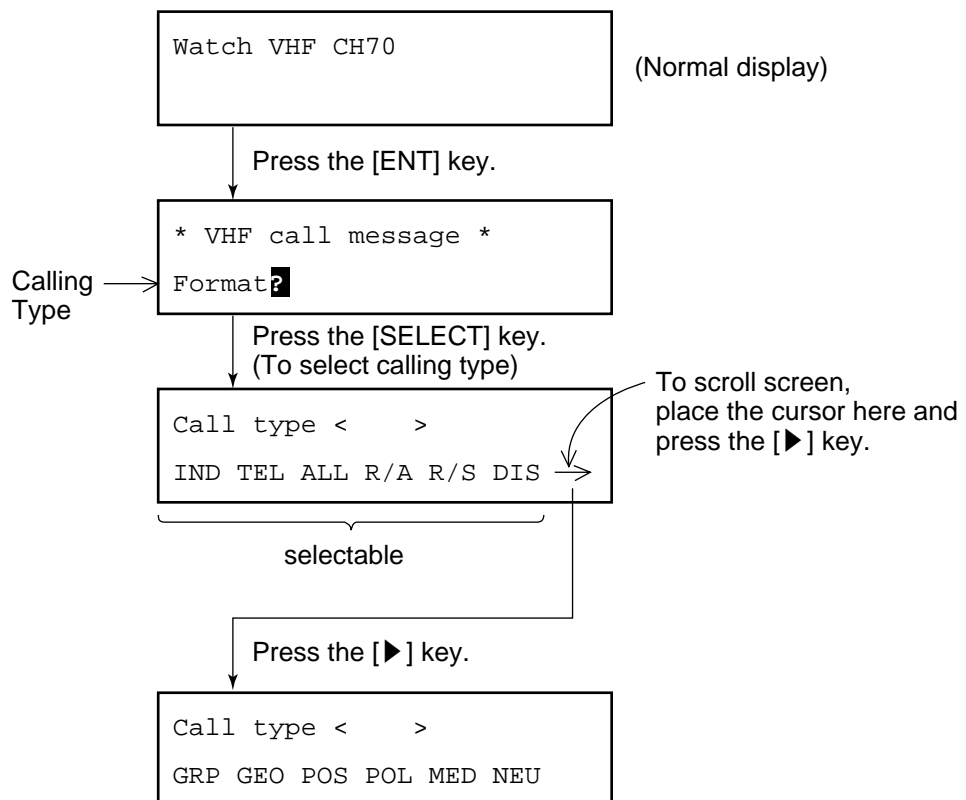

Description of all 12 calling types appears on the next pages.

- **IND** :Individual call (Refer to page 4-1.)
- **TEL** :Telephone call (semi-auto/auto call. Refer to page 5-4.)
Call a terrestrial network, for example, your office through a coast station.
- **ALL** :All ships call (Refer to page 4-9.)
- **R/A and R/S** :Distress relay for All ships and for Selective (Individual) calls (Refer to page 3-5.)
- **DIS** :Distress call (Refer to page 3-1.)
- **GRP** :Group call
Call a specific group by entering group ID number.
- **GEO** :Georgraphic area call
Call for ships within a range set by you in the transmit message (menu). To designate the range, enter reference point and width (range) data of both longitude and latitude.

Example: Ocean AD ... 34N 135E da10 do5
}
Range data

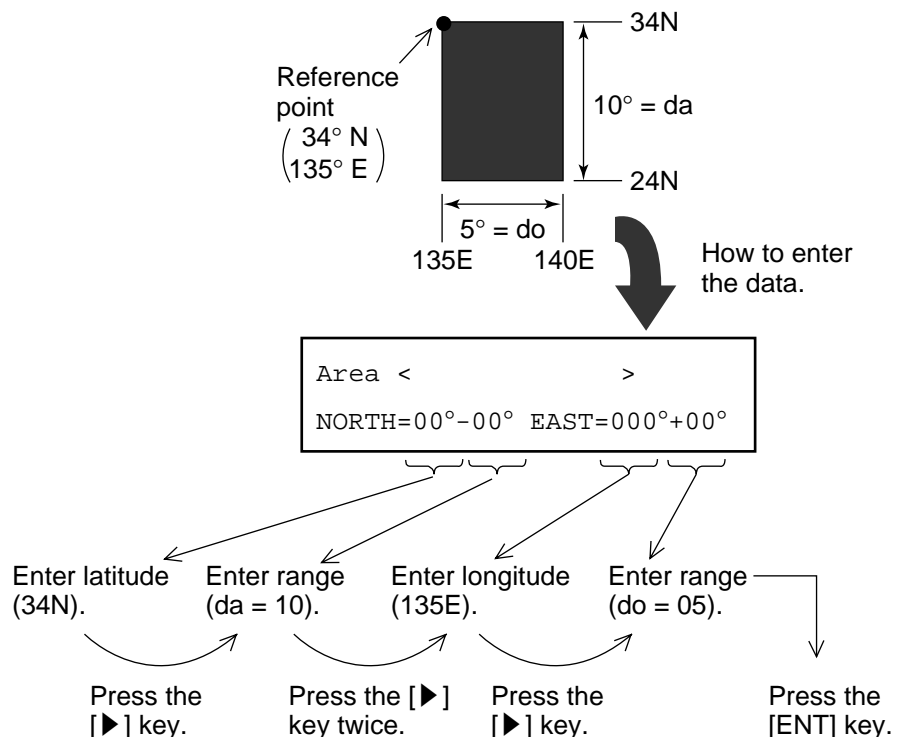

5.2 Making Telephone Calls

When the coast station serves PSTN telephone service you can make Telephone Call via Coast Station.

Basic procedure

1. Selection of Format specifier.
2. Entry of Coast Station ID.
3. Entry of Telephone number.

Detailed procedure

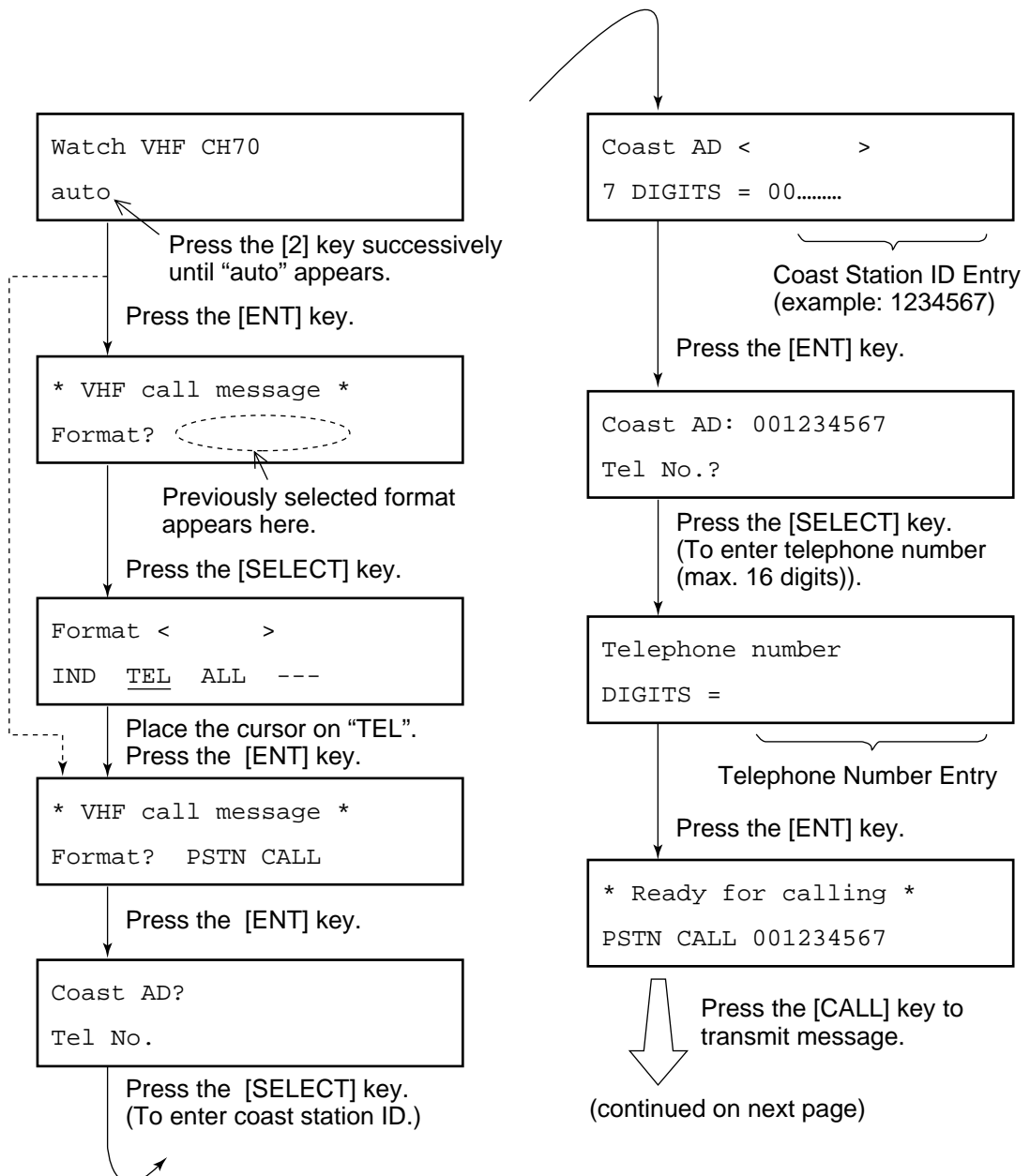

(from previous page)

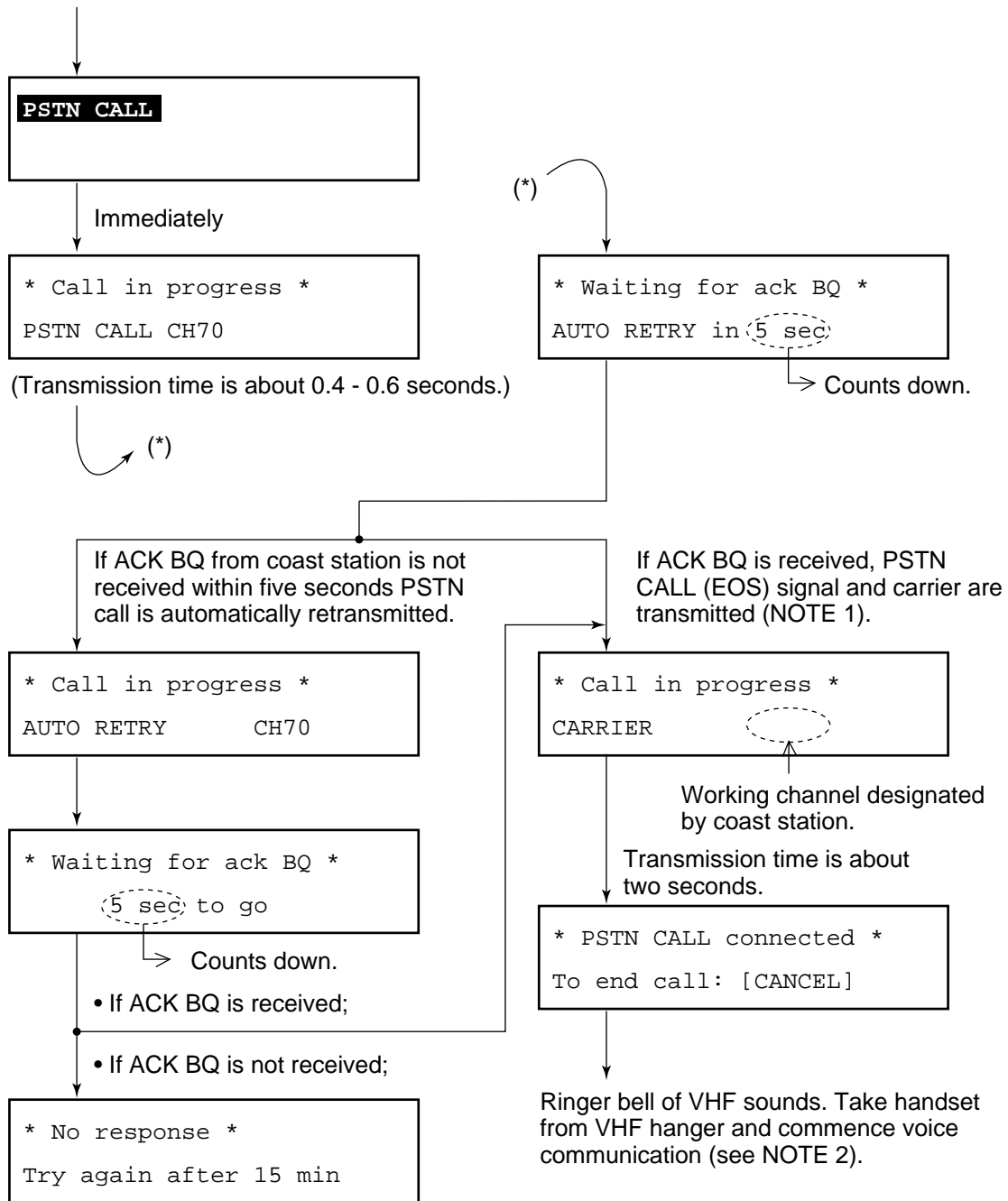

Recall after 15 minutes.

(NOTE 1) When you receive "unable to comply" (BUSY) command instead of "able", the FM-8500 waits for "Ring back call" from coast station for 15.5 minutes. Then, if it is received, carrier is automatically transmitted.

(NOTE 2) If there is no reply (voice response) from subscriber within one minute at "PSTN CALL connected" display, the communication line will be disconnected. The display should look something like the display ② on the page 5-7. If you hang the handset on the hanger, the display ① shown on the next page appears to break the communication line.

Operation after making DSC call

Voice communication is started. After completion of communication, the display changes as shown in (1) or (2) below depending on how voice communication terminated.

(1) When you end voice communication by pressing the [CANCEL] key or hanging the handset on the hanger of the VHF, the display of the FM-8500 changes as follows.

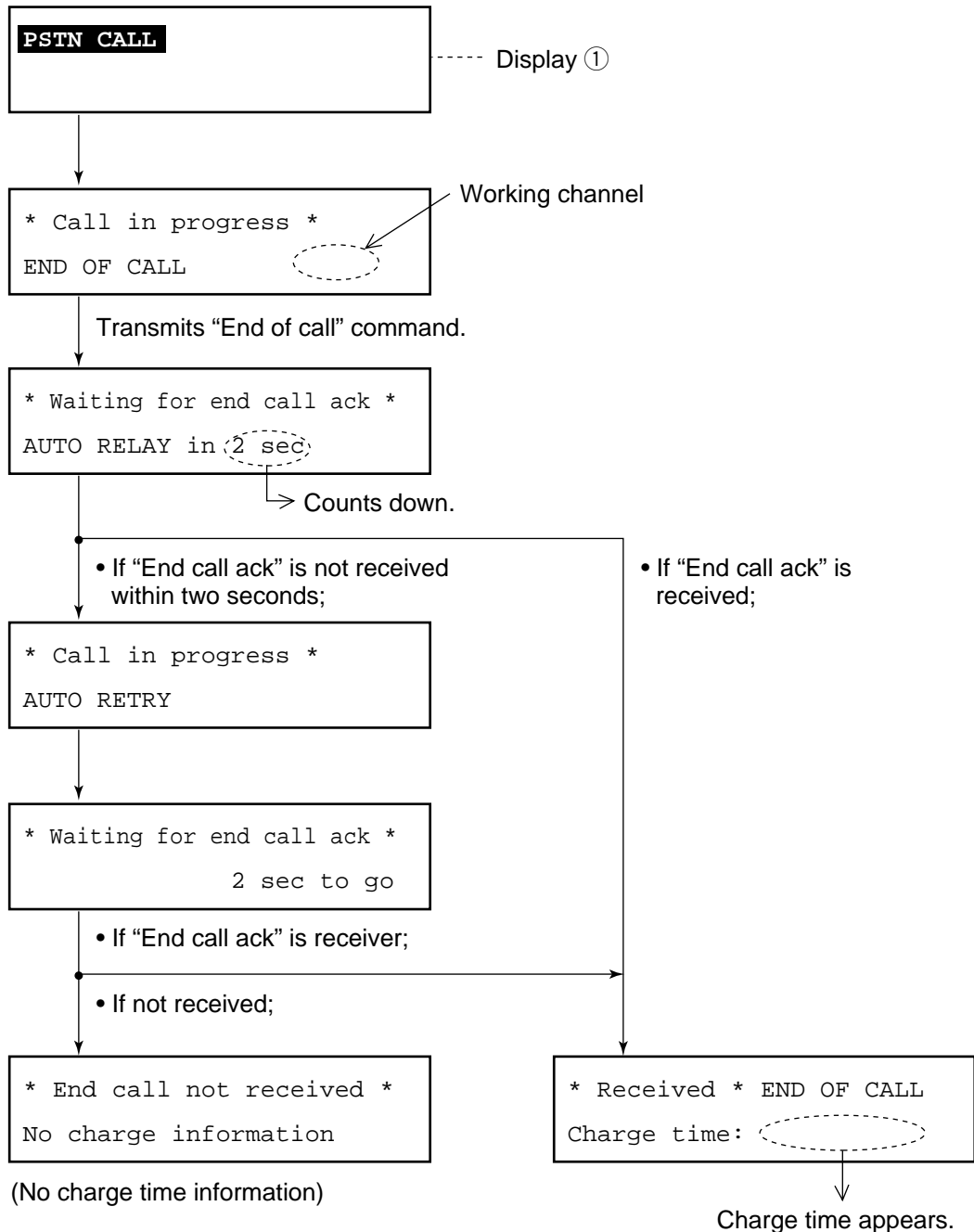

- (2) When coast station terminates communication, the display of the FM-8500 is as follows.

When the "End of call" command from coast station is received;

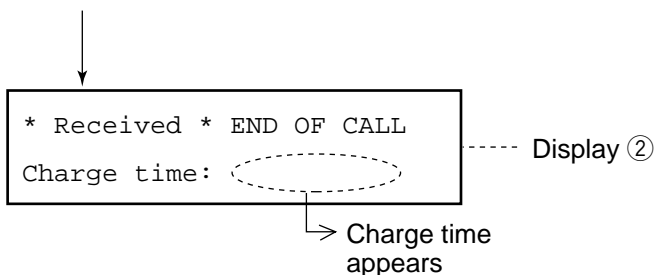

NOTE: If a subscriber hangs the handset on the hanger to terminate voice communication, coast station will transmit the "End of call" command to you to break the communication line.

5.3 Receiving Telephone Call from Coast Station

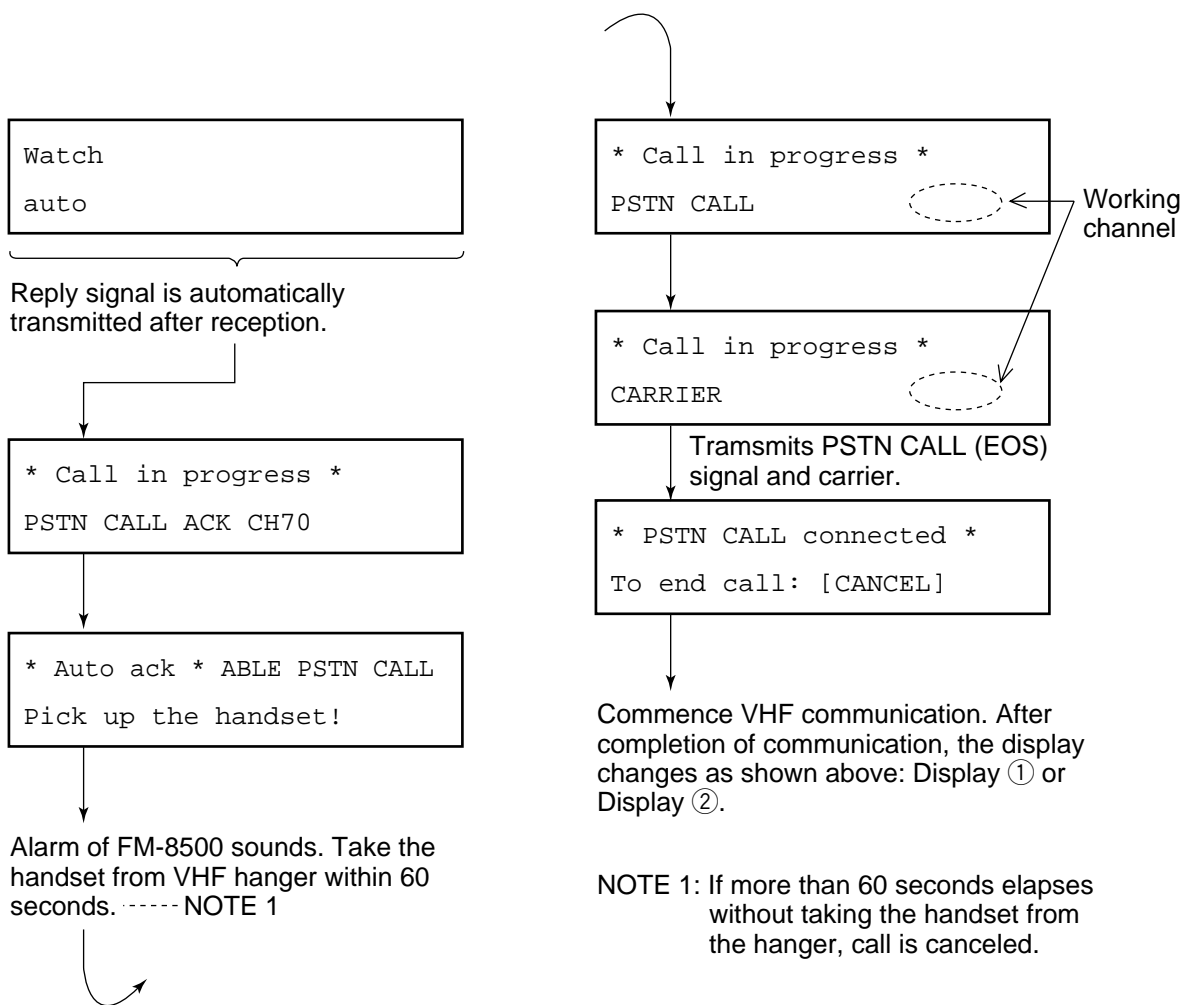

5.4 Other Station IDs and Telephone Nos.

Registering

You can program often-used station IDs and telephone numbers under a file name.

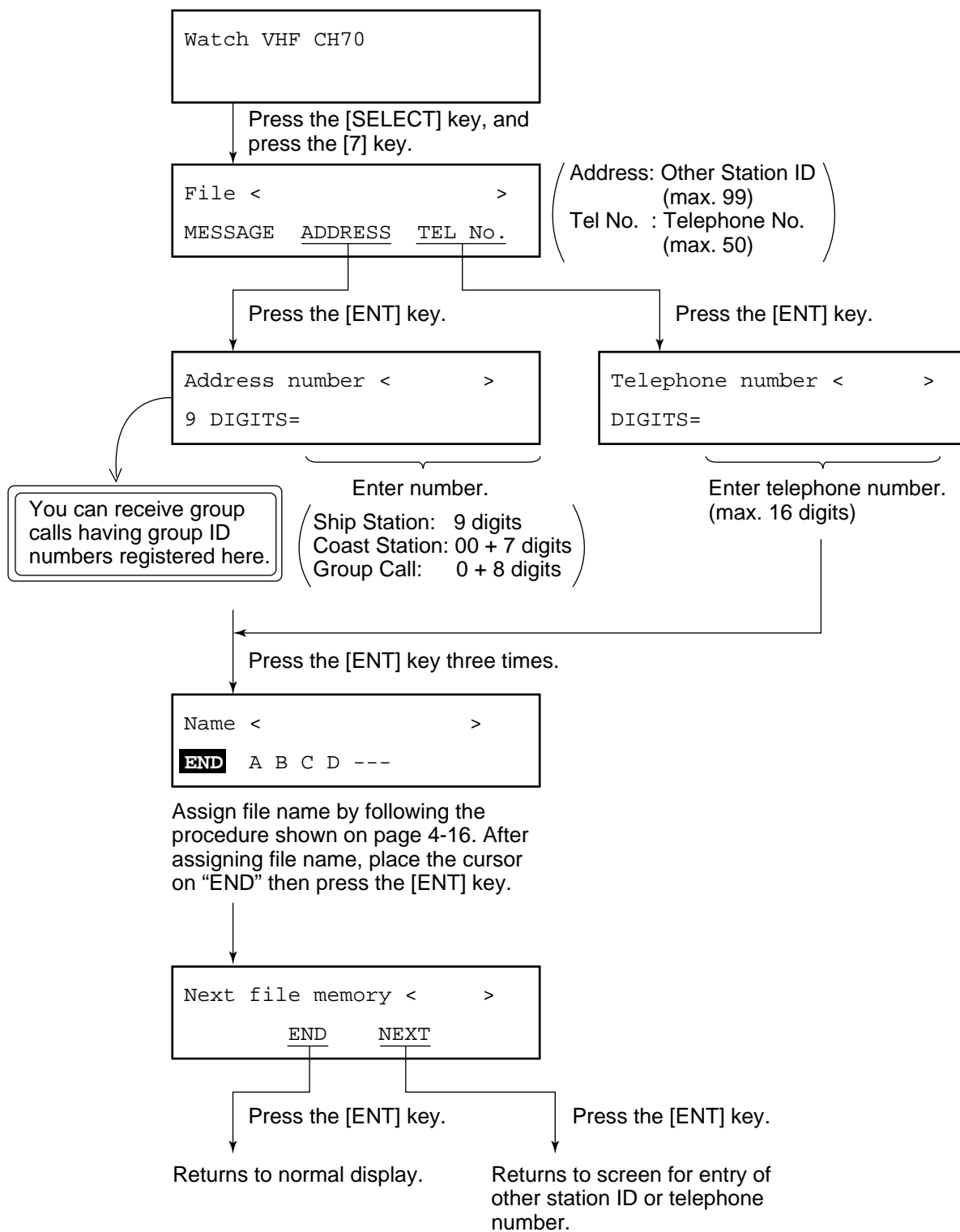

Retrieving

You can retrieve a file registered on previous page, and use it with message which you are currently preparing.

To retrieve a file, **press the [7 (FILE)] key on a display where the blinking question mark appears.**

[Example]

1. Retrieving Other Station ID

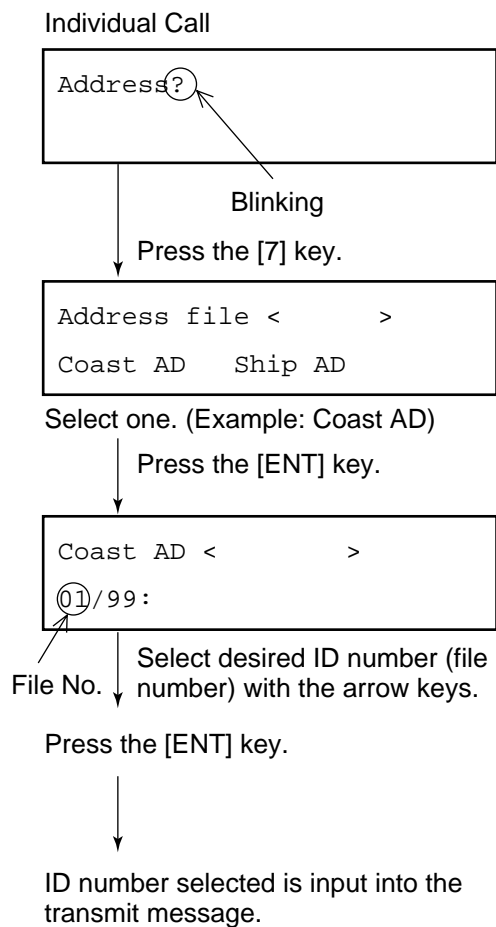

2. Retrieving Telephone Number

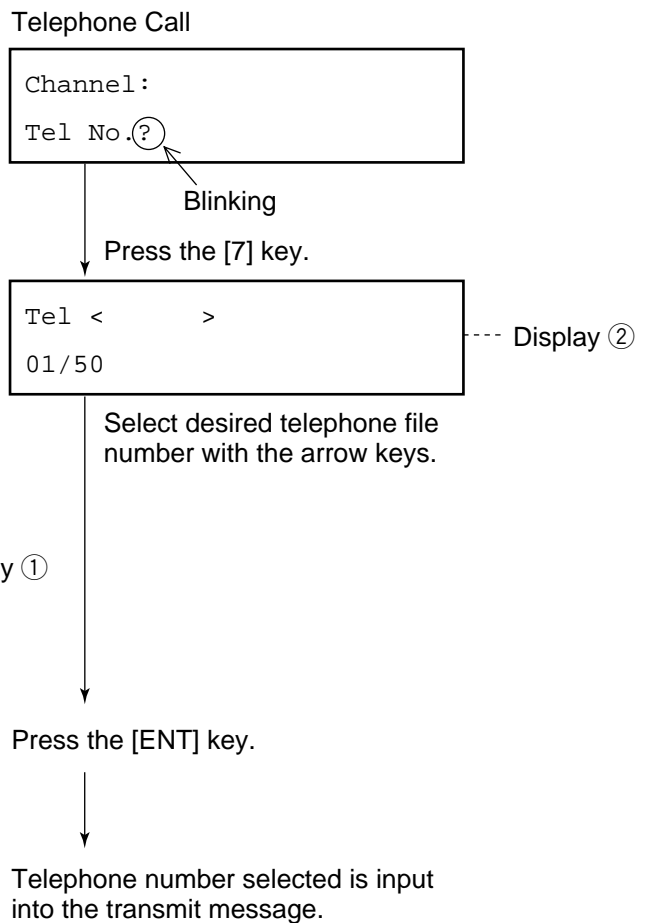

Note: Each press of the [SELECT] key at display ① or display ② alternates file number and alphabet prefixed file name.

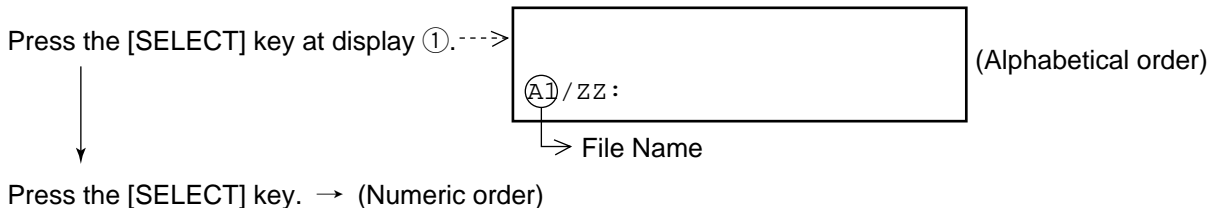

This page is intentionally left blank.

6. Other Settings

6.1 Printer Setup (Auto/Manual)

You can select either automatic or manual printing by following the procedure shown below. (Factory setting: Auto)

Procedure

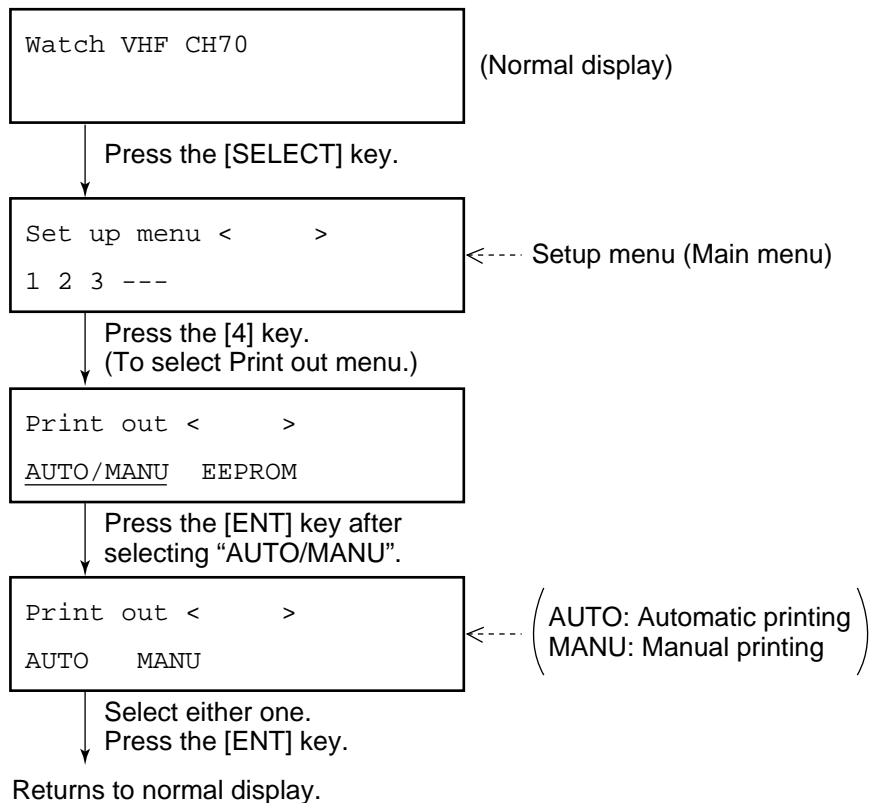

Automatic printing

With connection of the optional printer and “AUTO” is selected as above, all transmitted and received messages will be automatically printed out when transmitted and received.

Manual printing

When “Manual” is selected, press the [4 (PRINT)] key to print out message desired. Note that manual printing is available even when “AUTO” is selected.

The contents to be printed depend on when the [4] key is pressed, as shown in the table below.

No.	Printing	Timing of [4] key pressing	Example Printout
1	Contents of {VHF call message}	During “VHF call message” display to “Ready for calling” display	Ⓐ
2	Contents of all transmitted logs {Xmitted log No. < >}	Displayed [Xmitted log No. < >] (To stop printing, press the [CANCEL] key.)	Ⓑ
3	Contents of specific log no. (for example, log no. 1) {Xmitted log No. <1/50>} Press the [ENT] key.	During “[Xmitted...] ⇨ Press the [ENT] key.” display to “EOS” display.	Ⓒ
4	Call message (again) Call again CALL END... Press the [ENT] key.	Channel? to Ready for calling While these displays appears	Ⓐ
5	Contents of all received logs {Ordinary log No. < >} (Distress)	Displayed [Ordinary log No. < >] (Distress) (To stop printing, press the [CANCEL] key.)	Ⓓ
6	Contents of specific log no. (for example, log no. 1) {Ordinary log No. <1/50>} (Distress)	[Ordinary...] display ⇨ Press the [ENT] key.	Ⓔ
7	① Currently received message * Received * Press the [ENT] key.	to ECC: OK While these displays appears	
	② Acknowledge message Acknowledge call < >	“Ready for calling” is displayed.	Ⓕ
8	Contents of currently prepared {VHF call message M}	During “VHF call message M” display to “Ready for filing” display.	Ⓖ
9	All lists of {saved message} or contents of all {Address or Tel No.} files. • Press the [SELECT] key. ⇨ Press the [7] key. File < > Message Address Tel No.	• For example, to print out all coast addresses in the memory, press the [4] key at display ① on page 5-9. Press the [4] key to print out all list of saved messages.	Ⓖ

Example printout

- a**
- ```
Format : INDIVIDUAL
Address : 000000000
Category : Routine
Telecom1 : DUPLEX TP
Telecom2 : RES No.18
Channel : 23
EOS : ACK RQ
ECC :

DSC ch : 70
```
- b**
- ```
***** Xmitted log *****
Xmt message 12:34
Format : INDIVIDUAL
Address : 004310000
Category : Routine
Telecom1 : DUPLEX TP
Telecom2 : RES No.18
Channel : 23
EOS : ACK BQ

DSC ch : 70
```
- c**
- ```
Xmt message 00:09
Format : INDIVIDUAL
Address : 004310000
Category : Routine
Telecom1 : DUPLEX TP
Telecom2 : RES No.18
Channel : 23
EOS : ACK RQ

DSC ch : 70
```
- d**
- ```
***** Ordinary log *****
Rcv message 02:04
Format : ALL SHIPS
Category : Safety
Telecom1 : SIMPLEX TP
Telecom2 : RES No.18
Channel : 16
EOS : EOS
ECC : OK

DSC ch : 70

Xmt message 02:03
Format : INDIVIDUAL
Address : 004310000
Category : Safety
Telecom1 : SIMPLEX TP
Telecom2 : RES No.18
Channel : No information
EOS : ACK RQ
ECC : OK

DSC ch : 70
```
- e**
- ```
Rcv message 00:07
Format : INDIVIDUAL
Address : 431000001
Category : Routine
Telecom1 : DUPLEX TP
Telecom2 : RES No.18
Channel : 23
EOS : ACK RQ
ECC : OK

DSC ch : 70
```
- f**
- ```
Format : INDIVIDUAL
Address : 431000001
Category : Routine
Telecom1 : DUPLEX TP
Telecom2 : RES No.18
Channel : 23
EOS : ACK BQ

DSC ch : 70
```
- g**
- ```
Format : INDIVIDUAL
Address : 000000000
Category : Routine
Telecom1 : DUPLEX TP
Telecom2 : RES No.18
Channel : 23
EOS : ACK RQ
ECC : OK

DSC ch : 70
```
- e**
- ```
**** Call message file ****
01: FURUNO Individual
02: CAPTAIN All ships
```

6.2 Turning Keyboard Click ON/OFF

You can turn keyboard click (response) on or off as follows:

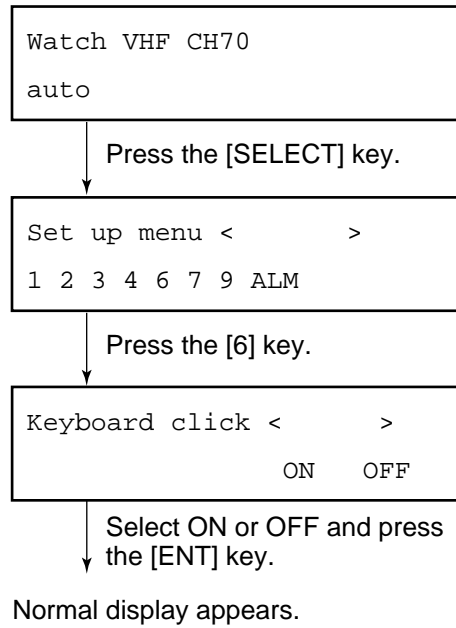

6.3 Aural Alarm Setup

The aural alarm which sounds when messages other than distress and urgency are received may be turned on or off and the distress alarm tone may be selected.

Procedure

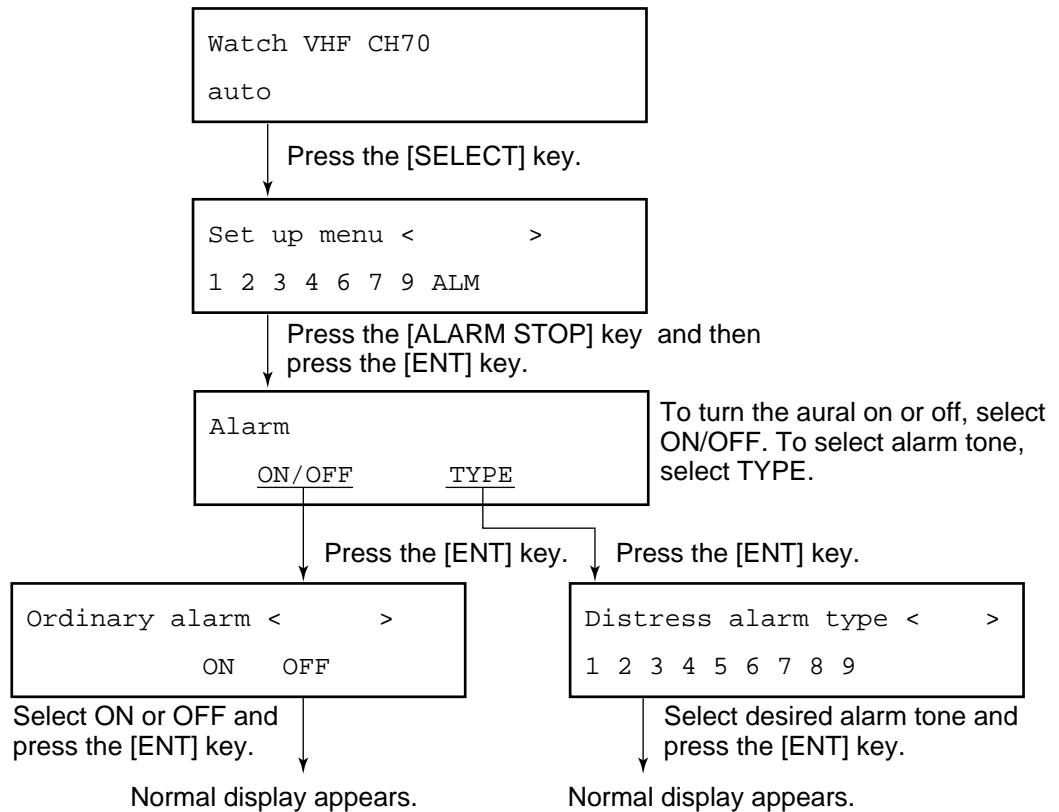

This page is intentionally left blank.

7. System Confirmation

Overview

This chapter shows how to confirm the system; no items can be changed.

7.1 Confirming Own Ship's ID

Own Ship's ID can be confirmed as follows:

Procedure

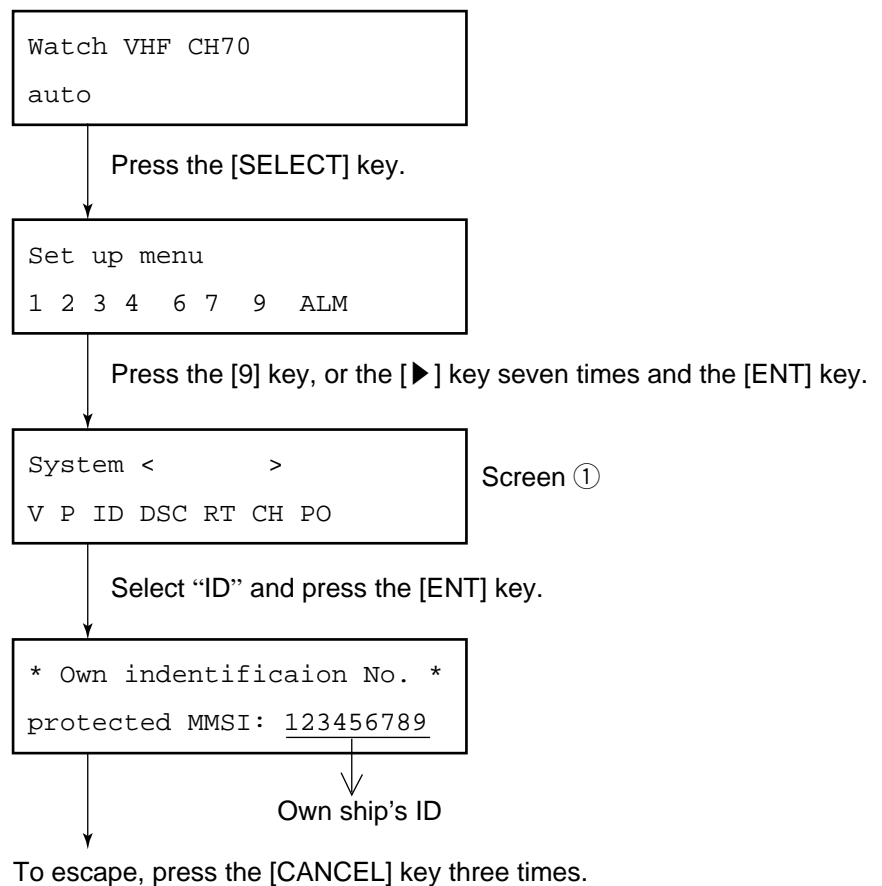

7.2 Confirming ROM Version

You can see ROM Version (as registered in the memory) as follows:

Procedure

At screen ① previous page, select “V” and press the [ENT] key.

```
ROM version
  RT:1.06   DSC:1.10
```

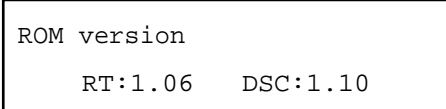

To escape, press the [CANCEL] key three times.

RT is the VHF section's ROM version.
DSC is the section's ROM version.

7.3 Confirming VHF Section Settings

You can confirm VHF section settings as follows:
If you want to change VHF section settings, contact FURUNO agent or dealer for service.

Procedure

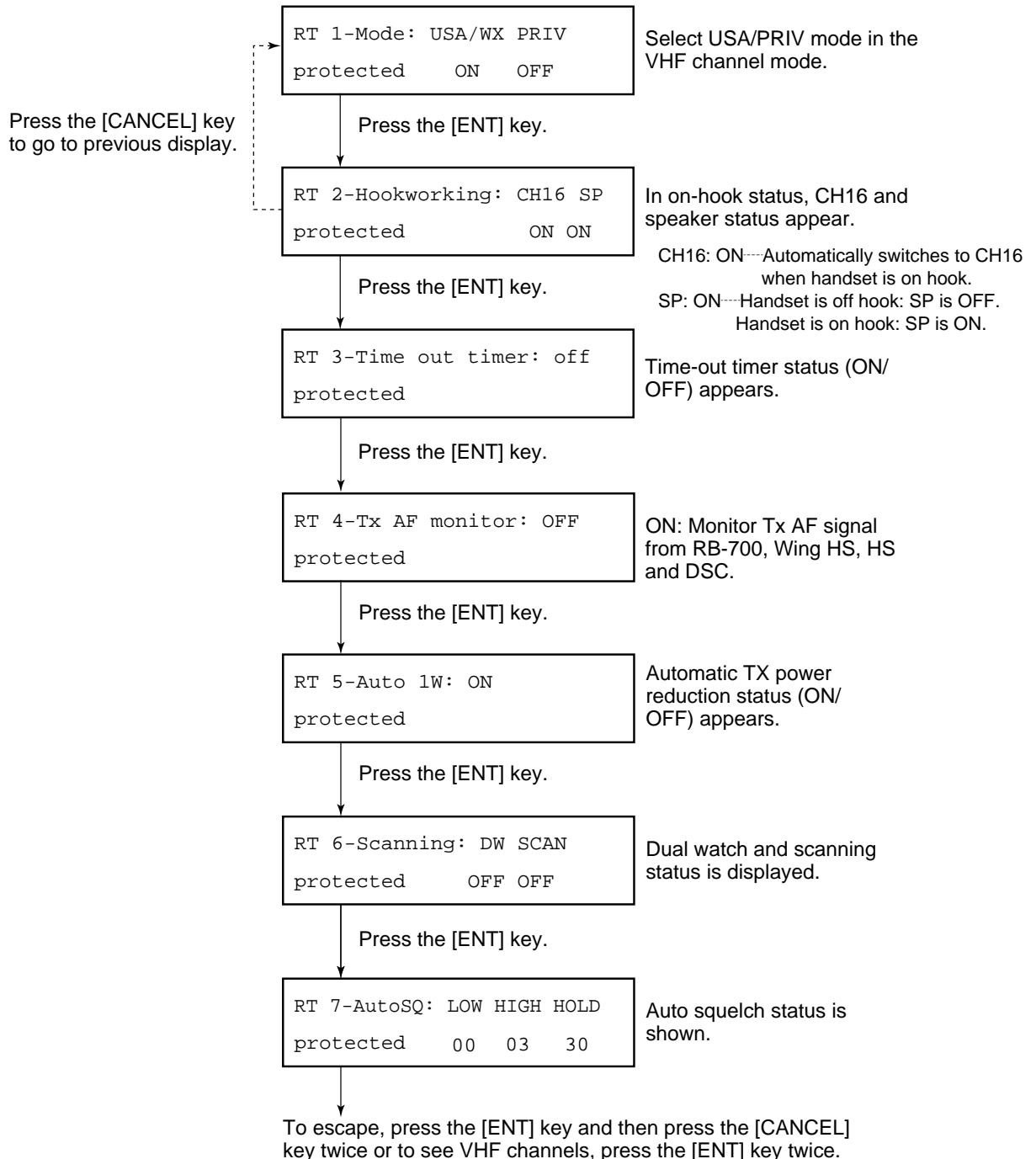

At screen ① on page 7-1, select “RT” and press the [ENT] key.

7.4 Confirming VHF Channels

You can confirm VHF channels registered as follows:

Procedure

At screen ①, select “CH” and press the [ENT] key.

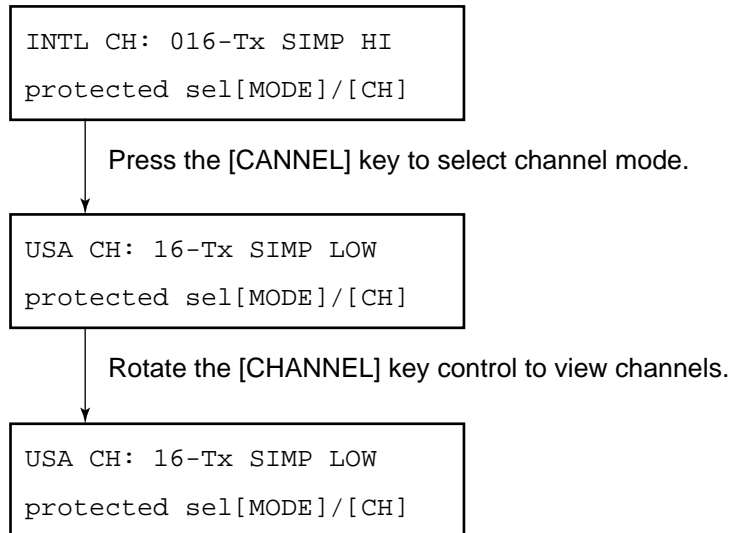

Do one of the following:

Continue channel confirmation: Operate the [CHANNEL] key.

Escape: Press the [CANCEL] key.

Confirm Tx power: Press the [ENT] key twice.

VHF channel status

Tx : Tx/Rx	SIMP (Simplex)	HI (25W)
Rx : Rx only	DUP (Duplex)	LOW (1W)
Unable : Channel not used		

7.5 Confirming Tx Output Power

The Tx output power on three VHF bands (low, CH60; med, CH14, high, CH88) can be confirmed as shown below. Tx output power on private mode channels can also be confirmed if applicable.

Procedure

At screen ① on page 7-1, select “PO” and press the [ENT] key.

To escape, press the [CANCEL] key three times. The normal display appears.

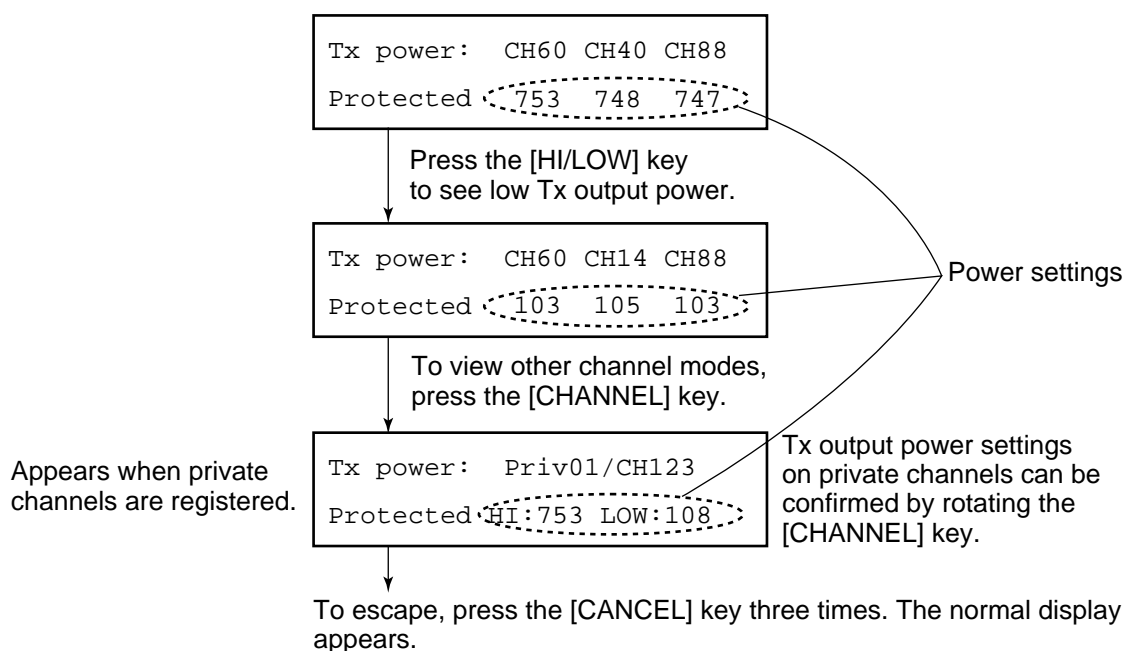

This page is intentionally left blank.

8. Maintenance & Troubleshooting

8.1 Maintenance

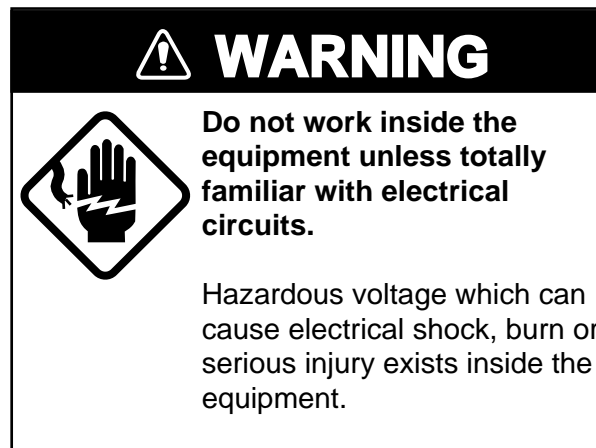

Antenna connectors

1. Check that each connector is firmly connected.
2. Clean corroded or soiled connectors.
3. Check coaxial cable for damage. If damaged, replace.
4. Check that bolts fixing the antenna are firmly tightened.

8.2 Troubleshooting

When the power cannot be turned on

1. Check if power plug is firmly connected.
2. Check breaker at the rear of the equipment. If it has tripped, push it in to reset.
3. If power cannot be turned on, contact a FURUNO agent or representative.

8.3 Diagnostic Test

Regulations require that the DSC section be checked daily for proper operation.

Procedure

Select a channel not in use and press and hold down the PTT switch of the handset for more than one second before starting self test.

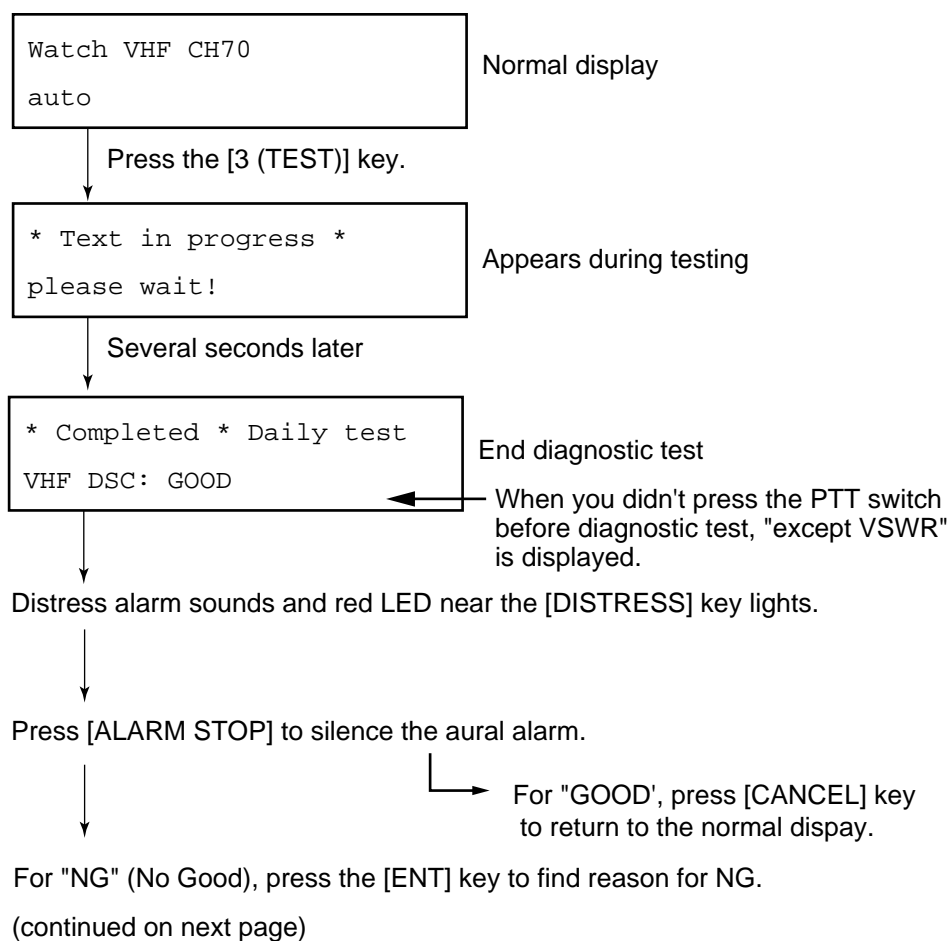

(from previous page)

↓
Press [ENT] to view results of test.



↓
Check end: [CANCEL] key

TRANSMIT POWER : NG
= P.A. of transmission section
error or Antenna

TX PCB(PLL LOCK) : NG
= PLL(U5) error on the Tx PCB

CONTROL PCB : NG
= MODEM(U29) error on the Control PCB
or
CH70 Rx PCB: NG
= VHF RX/CH70 RX PCB error

Press the [◀] key. To escape, press the [CANCEL] key.
If NG appears, have a technician replace corresponding p.c. board.

NOTE: Do not open the equipment at any time. Electrical shock hazard exists inside the equipment. Contact FURUNO agent or dealer for service.

This page is intentionally left blank.

9. Specifications

General

Channel Programs:	INTL Channel: 55 USA Channel: 55 WX Channel: 10 PRIV Channel: 20 (authorization required)
Oscillator:	PLL synthesizer
Communication System:	Semi-duplex & Simplex
Class of Emission:	G3E, G2B
Antenna Impedance:	50 Ω
Dimensions and Mass:	258 (W) X 108 (H) X 230 (D) mm, 5kg
Temperature:	-20°C to 55°C
Relative Humidity:	93% at +40°C;
Waterproofing:	Panel: IEC529 IPX4 Chassis: IEC529 IPX2
Power Supply:	24 VDC -10% ~ +30% Transmit: 150 W Receive: 10 W
Color:	Panel: Munsell N3.0 Chassis: Munsell 2.5GY 5/1.5

Transmitter

Frequency Range:	155.00 to 161.475 MHz
RF Output Power:	25W (HI), 1W (LOW)
Modulation AF Response:	Within +1/-3 of 6dB/oct pre-emphasis characteristics at 300 to 3000 Hz
Frequency Deviation:	± 5 kHz max.
Spurious Emission:	Less than 0.25 μ W
Modulation System:	Reactance Type

Receiver

Frequency Range:	155.000 to 166.075 MHz
Receiving System:	Double-Conversion Superheterodyne
Intermediate Frequency:	First IF: 21.4 MHz Second IF: 455 kHz
Sensitivity:	-8dBmV at SINAD 12 dB
Adjacent Channel Selectivity:	70 dB min.
Spurious Response Rejection:	70 dB min.
Audio Output:	Internal Speaker: 3W min. (8ohms) Handset: 2mW min. (200ohms)

DSC Section

Protocol:	Complies with ITU-R Rec. M.493-9 (ClassA), M.541-8 and M.689-2
Modulation Rate:	1200 baud -30 p.p.m. max.
Modulation:	AFSK
Modulation Frequency:	Mark: 1300 Hz -10 Hz max. Spece: 2100 Hz -10 Hz max.
Nav. Equipment Interface:	IEC61162-1 (NMEA0183 Ver. 2.00)
CH70 Receiver Sensitivity:	Symbol Error Rate 10^{-2} , input -3dBmV

10. Menu List

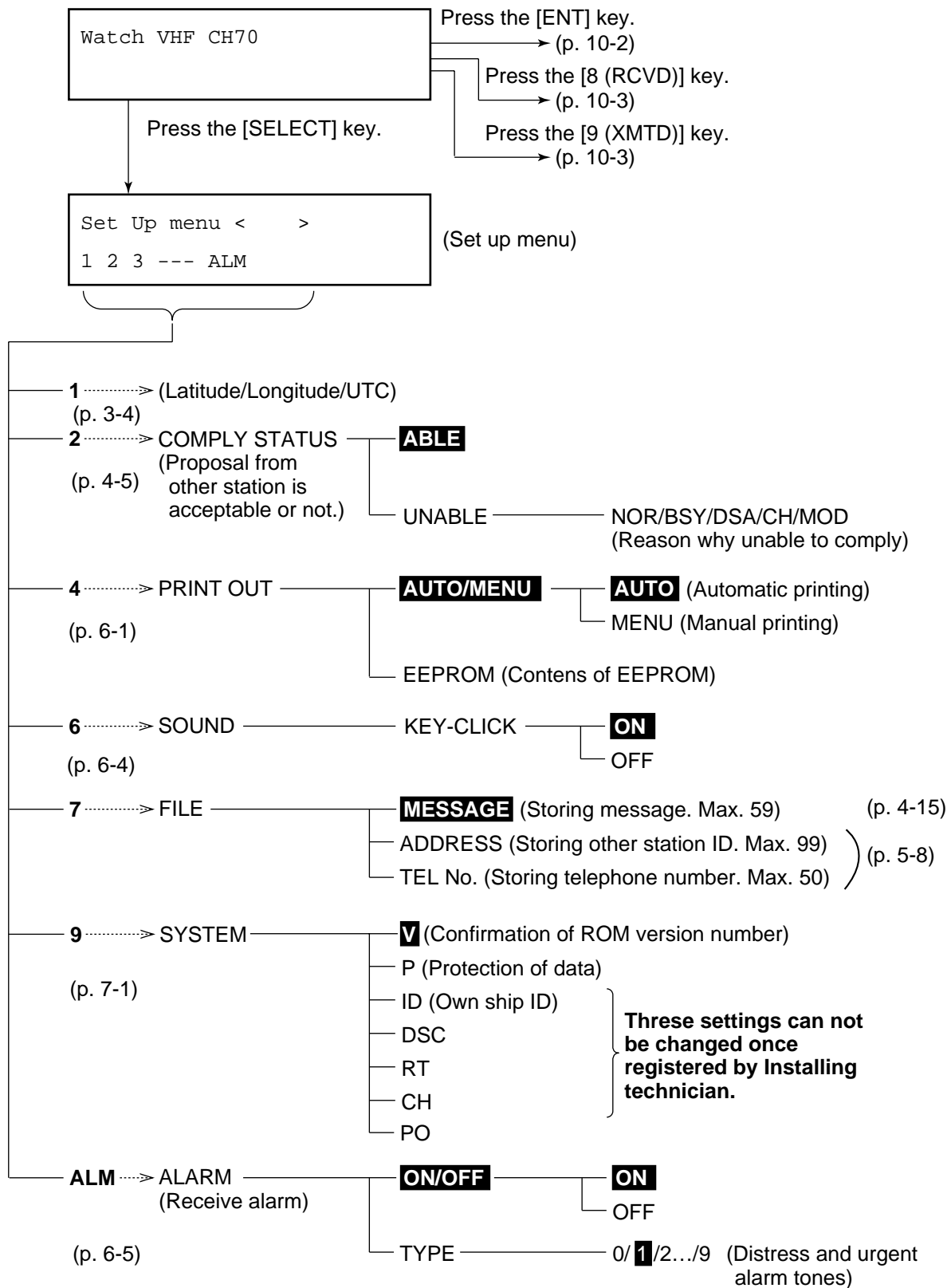

Default settings shown in highlight.

- Normal display

Press the [ENT] key.

* VHF Call message *
Format ?

(Preparing transmit message)

FORMAT

- INDIVIDUAL — ADDRESS — CATEGORY — TELECOM — WORKING CH
- TELEPHONE — COAST ADDR — TEL NO.
(DIALPHONE)
- ALL SHIPS — CATEGORY — TELECOM — WORKING CH
- R/A (DISTRESS RELAY...ALL SHIPS) — DIST SHIP ID — N. OF DIST — POS & TIME
- R/S (DISTRESS RELAY...INDIVIDUAL) — COAST ADDR
- DISTRESS — NATURE OF DISTRESS — POSITION & TIME
- GROUP — GROUP ADDR — CATEGORY — TELECOM — WORKING CH
- GEOGRAPHIC AREA
— OCEAN ADDR — CATEGORY — TELECOM — WORKING CH
- POSITION REQUEST — ADDR — CATEGORY — TELECOM (POSITON)
(Normally ROUTINE)
- POLLING — ADDR — CATEGORY — TELECOM (POLLING)
(Normally ROUTINE)
- MEDICAL TRANSPORT — TELECOM — WORKING CH
- NEURAL CRAFT — CATEGORY — WORKING CH

• Normal display

Press the [8 (RCVD)] key.

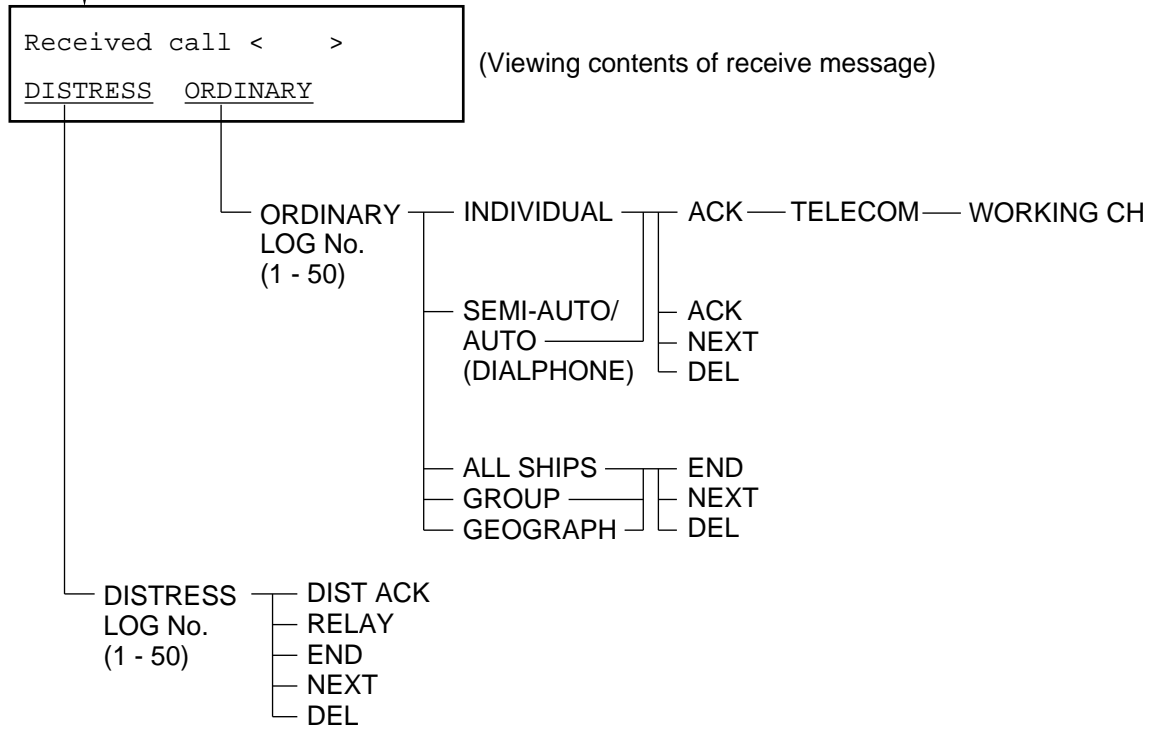

• Normal display

Press the [9 (XMTD)] key.

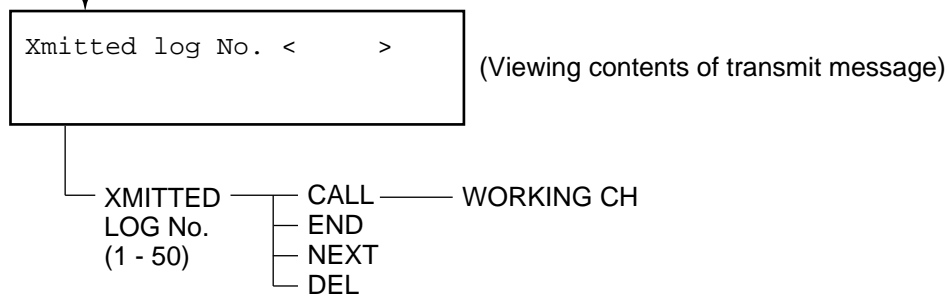

This page is intentionally left blank.

APPENDIX 1

Marine VHF Channel Lists

INTERNATIONAL CHANNELS

CH	TX	RX	CH	TX	RX
01	156.050	160.850	60	158.025	160.625
02	156.100	160.700	61	158.075	160.675
03	156.150	160.750	62	158.125	160.725
04	156.200	160.800	63	158.175	160.775
05	156.250	160.850	64	158.225	160.825
06	156.300	158.300	65	158.275	160.875
07	156.350	160.950	66	158.325	160.925
08	156.400	158.400	67	158.375	158.375
09	156.450	158.450	68	158.425	158.425
10	156.500	158.500	69	158.475	158.475
11	156.550	158.550	70	158.525	158.525
12	156.600	158.600	71	158.575	158.575
13	156.650	158.650	72	158.625	158.625
14	156.700	158.700	73	158.675	158.675
15	156.750	158.750	74	158.725	158.725
16	156.800	158.800	77	158.875	158.875
17	156.850	158.850	78	158.925	161.525
18	156.900	161.500	79	158.975	161.575
19	156.950	161.550	80	157.025	161.625
20	157.000	161.600	81	157.075	161.675
21	157.050	161.650	82	157.125	161.725
22	157.100	161.700	83	157.175	161.775
23	157.150	161.750	84	157.225	161.825
24	157.200	161.800	85	157.275	161.875
25	157.250	161.850	86	157.325	161.925
26	157.300	161.900	87	157.375	161.975
27	157.350	161.950	88	157.425	162.025
28	157.400	162.000			

(MHz)

USA CHANNELS

CH	TX	RX	CH	TX	RX
01A	156.050	158.050	60	158.025	160.625
02A	156.100	158.100	61	158.075	160.675
03A	156.150	158.150	62	158.125	160.725
04A	156.200	158.200	63A	158.175	158.175
05A	156.250	158.250	64	158.225	160.825
06	156.300	158.300	65A	158.275	158.275
07A	156.350	158.350	66A	158.325	158.325
08	156.400	158.400	67	158.375	158.375
09	156.450	158.450	68	158.425	158.425
10	156.500	158.500	69	158.475	158.475
11	156.550	158.550	70	158.525	158.525
12	156.600	158.600	71	158.575	158.575
13	156.650	158.650	72	158.625	158.625
14	156.700	158.700	73	158.675	158.675
15		158.750	74	158.725	158.725
16	156.800	158.800	77	158.875	158.875
17	156.850	158.850	78A	158.925	158.925
18A	156.900	158.900	79A	158.975	158.975
19A	156.950	158.950	80A	157.025	157.025
20	157.000	161.600	81A	157.075	157.075
21A	157.050	157.050	82A	157.125	157.125
22A	157.100	157.100	83A	157.175	157.175
23A	157.150	157.150	84	157.225	161.825
24	157.200	161.800	85	157.275	161.875
25	157.250	161.850	86	157.325	161.925
26	157.300	161.900	87	157.375	161.975
27	157.350	161.950	88A	157.425	157.425
28	157.400	162.000			

(MHz)

WEATHER CHANNELS

CH	RX
WX0	163.275
WX1	162.550
WX2	162.400
WX3	162.475
WX4	162.425
WX5	162.450
WX6	162.500
WX7	162.525
WX8	161.650
WX9	161.775

(MHz)

APPENDIX 2 Memory Channel List

MEMO NO.	CHANNEL		REMARKS
	INTL	USA	
0	WX	PRIV	
	INTL	USA	
1	WX	PRIV	
	INTL	USA	
2	WX	PRIV	
	INTL	USA	
3	WX	PRIV	
	INTL	USA	
4	WX	PRIV	
	INTL	USA	
5	WX	PRIV	
	INTL	USA	
6	WX	PRIV	
	INTL	USA	
7	WX	PRIV	
	INTL	USA	
8	WX	PRIV	
	INTL	USA	
9	WX	PRIV	
	INTL	USA	
10	WX	PRIV	
	INTL	USA	
11	WX	PRIV	
	INTL	USA	
12	WX	PRIV	
	INTL	USA	
13	WX	PRIV	
	INTL	USA	
14	WX	PRIV	
	INTL	USA	
15	WX	PRIV	
	INTL	USA	
16	WX	PRIV	
	INTL	USA	
17	WX	PRIV	
	INTL	USA	
18	WX	PRIV	
	INTL	USA	
19	WX	PRIV	
	INTL	USA	

APPENDIX 3

Digital Interface (IEC 61162-1 Edition 2)

Input sentences

GGA, GLL, RMA, RMC, ZDA

Schematic diagram

NMEA

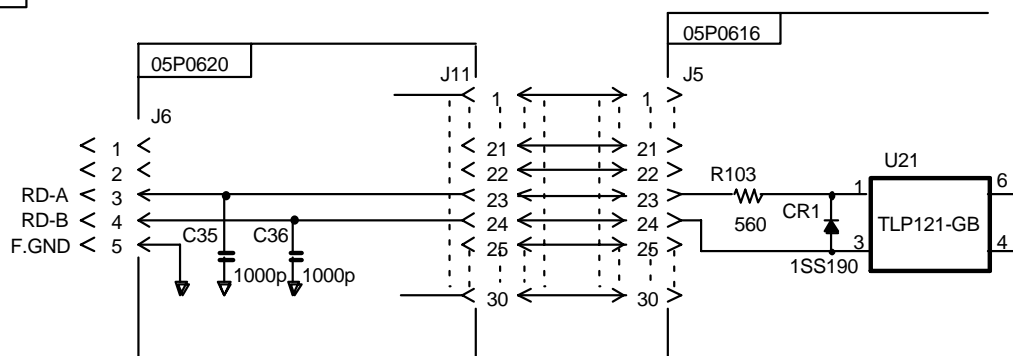

Load requirements as listner

Isolation	Optocoupler
Input impedance	560 ohms
Max. Voltage	$\pm 15V$
Threshold	4 mA

GGA - Global positioning system (GPS) fix data

\$--GGA,hhmmss.ss,llll.lll,a,yyyyy.yyy,a,x,xx,x.x,x.x,M,x.x,M,x.x,xxxx*hh<CR><LF>

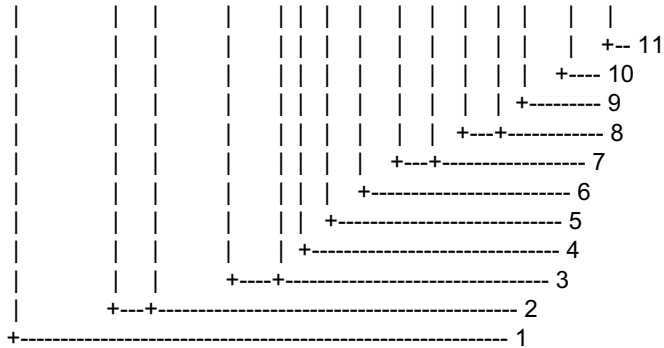

1. UTC of position
2. Latitude, N/S
3. Longitude, E/W
4. GPS quality indicator (see note)
5. Number of satellite in use,00-12, may be different from the number in view
6. Horizontal dilution of precision
7. Antenna altitude above/below mean sealevel, m
8. Geoidal separation, m
9. Age of differential GPS data
10. Differential reference station ID, 0000-1023
11. Checksum

NOTE

- 0 = fix not available or invalid
- 1 = GPS SPS mode, fix valid
- 2 = differential GPS, SPS mode, fix valid
- 3 = GPS PPS mode, fix valid
- 4 = Real Time Kinetic. Satellite system used in RTK mode with fixed integers
- 5 = Float RTK. Satellite system used in RTK mode with floating fingers
- 6 = Estimated (dead reckoning) mode
- 7 = Manual input mode
- 8 = Simulator mode

The GPS quality indicator shall not be a null field.

GLL - Geographic position - latitude and longitude

\$--GLL,III.III,a,yyyyy.yyy,a,hhmmss.ss,A,a*hh<CR><LF>

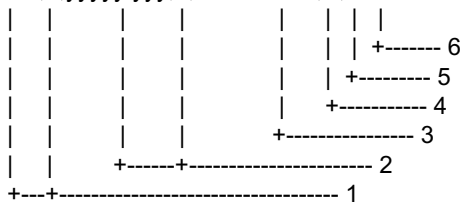

1. Latitude, N/S
2. Longitude, E/W
3. UTC of position
4. Status: A=data valid, V=data invalid
5. Mode indicator(see note)
6. Checksum

NOTE Positioning system Mode indicator:

- A = Autonomous
- D = Differential
- E = Estimated (dead reckoning)
- M = Manual input
- S = Simulator
- N = Data not valid

The Mode indicator field supplements the Status field. The Status field shall be set to V=invalid for all values of Operating Mode except for A=Autonomous and D=Differential. The positioning system Mode indicator and Status field shall not be null fields.

RMA - Recommended minimum navigation information - Loran C data

\$--RMA,A,IIII.III,a,yyyyy.yy,a,x.x,x.x,x.x,x.x,x.x,a,a*hh<CR><LF>

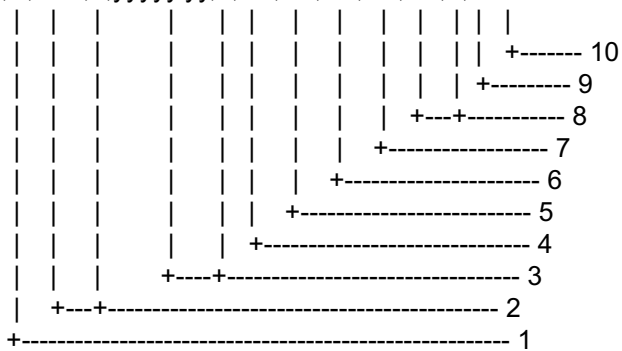

1. Status: A=data valid, V=blink, cycle or SNR warning
2. Latitude, degrees N/S
3. Longitude, degrees E/W
4. Time difference A, microseconds
5. Time difference B, microseconds
6. Speed over ground, knots
7. Course over ground, degrees true
8. Magnetic variation(see note 1),degree E/W
9. Mode indicator(see note 2)
10. Checksum

NOTE 1 - Easterly variation(E) subtracts from true course
Westerly variation(W) adds to true course

NOTE 2 Positioning system Mode indicator:

- A = Autonomous
- D = Differential
- E = Estimated (dead reckoning)
- M = Manual input
- S = Simulator
- N = Data not valid

The Mode indicator field supplements the Status field. The Status field shall be set to V=invalid for all values of Operating Mode except for A=Autonomous and D=Differential. The positioning system Mode indicator and Status field shall not be null fields.

RMC - Recommended minimum specific GPS/TRANSIT data

\$--RMC,hhmmss.ss,A,lll.lll,a,yyyyy.yyy,a,x.x,x.x,xxxxxx,x.x,a*hh<CR><LF>

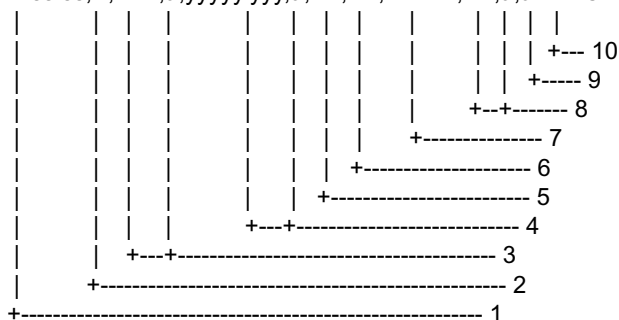

1. UTC of position fix
2. Status: A=data valid, V=navigation receiver warning
3. Latitude, N/S
4. Longitude, E/W
5. Speed over ground, knots
6. Course over ground, degrees true
7. Date: dd/mm/yy
8. magnetic variation, degrees E/W
9. Mode indicator(see note)
10. Checksum

NOTE Positioning system Mode indicator:

- A = Autonomous
- D = Differential
- E = Estimated (dead reckoning)
- M = Manual input
- S = Simulator
- N = Data not valid

The Mode indicator field supplements the Status field. The Status field shall be set to V=invalid for all values of Operating Mode except for A=Autonomous and D=Differential. The positioning system Mode indicator and Status field shall not be null fields.

ZDA-Data and time

\$--ZDA,hhmmss.ss,xx,xx,xxxx,xx,xx*hh<CR><LF>

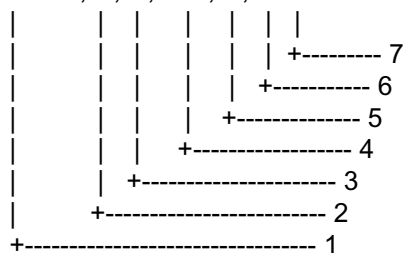

1. UTC
2. Day, 01 to 31(UTC)
3. Month, 01 to 12(UTC)
4. Year(UTC)
5. Local zone hours, 00h to +13h
6. Local zone minutes, 00 to +59
as local hours
7. Checksum

INDEX

A

arrow key 2-5

Automatic acknowledge 1-5

2-8

AUTO squelch 1-3

C

Calling Types 5-1

Comply status 4-5

10-1

D

DIS 2-1

F

Front panel 1-1

I

ID number 2-1

INTL 1-2

M

MAYDAY 3-3

N

Nature of distress 3-2

O

ON hook 4-12

P

Power settings 7-5

PRIV 1-2

PSTN call 5-4

Q

QUEUE INDICATION 4-4

R

ROU 2-1

U

USA 1-2

V

VHF transceiver v

VSWR 8-2

FURUNO**FURUNO ELECTRIC CO., LTD.**

9-52 Ashihara-Cho, Nishinomiya City, 662-8580, Hyogo, Japan

Tel: +81 798-65-2111 Fax: +81 798-65-4200

Pub NO. DOC-226

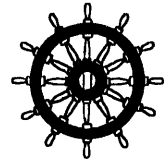
Declaration of conformity to typeWe **FURUNO ELECTRIC CO., LTD.**-----
(Manufacturer)

9-52 Ashihara-Cho, Nishinomiya City, 662-8580, Hyogo, Japan

(Address)

hereby declare under our sole responsibility that the product

VHF radio telephone with DSC model FM-8500 and its ancillary equipment: Printer interface IF-8500, Remote station RB-700, Distribution box DB-500, Printer PP-510, AC powersupply PR-300 and Distress message controller DMC-5

(Model names, type numbers)

to which this declaration relates conforms to the following standard(s) or normative document(s)

ETS 300 162: March 1998

ETS 300 338: November 1995

EN 60945: January 1997 (IEC 60945 Third edition: 1996-11)

(title and/or number and date of issue of the standard(s) or other normative document(s))

For assessment, see EC type-examination certificate N° KCS/99212005/AA/00 of 2 June 1999 issued by KCS Certification, The Netherlands

This declaration is issued according to the provisions of European Council Directive 96/98/EC on marine equipment modified by Commission Directive 98/85/EC.

On behalf of Furuno Electric Co., Ltd.

Hiroaki Komatsu
Manager,
International Rules and RegulationsNishinomiya City, Japan
June 16, 1999-----
(Place and date of issue)-----
(name and signature or equivalent marking of authorized person)